



Art & School Supplies Catalog 2019-2020

Let's
celebrate

BB.ca

Brault & Bouthillier
Education

75years
of being seriously
creative!

*More than ever, Brault & Bouthillier
is looking to the future and ready to face the challenges
of the future with you.*



1974

1976

Training

• 1979

1980

Brault & Bouthillier

is an accredited training organisation by the « Commission des partenaires du marché du travail » under the Act promoting workforce skills development and recognition.

B & B innovates once again by offering training courses to teachers, a first in Quebec.

With the support of its team of experienced and recognized instructors from the school community, Brault & Bouthillier accompanies educational professionals to ensure optimal use of the tools at their disposal.

Training and supporting teaching professionals is our calling. Brault & Bouthillier has been offering a wide range of training to educational professionals for 40 years.

Types of training offered

- Red carpet (« Tapis rouge ») days
- Arts / Visual arts
- Creative leisure
- Games and educational products: school daycare services / preschool / early years
- Makerspace
- Coding, science and technology
- Special needs
- Flexible setting

Let's celebrate
75years
of serious play!

For more information on the training we offer, speak to your representative or visit **The Tool Box** section
Look for this icon on www.bb.ca



Which paint should I use?

Tempera blocks and paint tray sets

Blocks of compressed pigments that are diluted with water using a brush or a paint brush, the opacity and the brightness of the colours varies according to the quality of the tempera. This tempera which is applied to porous materials such as paper and cardboard, results in vivid colours and a matte, velvety finish. Economical, easy to use and washes easily with water.

Liquid tempera

Liquid tempera is used primarily as-is, although it can be diluted with water. This tempera is designed to be applied to porous materials such as paper and cardboard. Liquid tempera is a water-based paint, covering, opaque that provides a matte and velvety finish. Temperas that are more creamy and concentrated in pigments are also more expensive. Washable and non-toxic.

Acrylic paint

Water-based paint that is permanent once dried. With greater adhesion power than tempera, it can be applied on various materials such as wood, plaster, paper mâché, clay, canvas and fabrics. Opaque paint of viscous consistency that is easy to clean in its wet state, but permanent and waterproof when dry.

Ink and watercolor

Watercolor comes in a tube, small pot or bottle (drawing ink) and is applied to porous materials. Watercolor being particularly brilliant and transparent, allows to work by superposition. More concentrated than the tempera blocks, the watercolor offers great dilution with water. Since watercolor techniques require a lot of water, heavy paper is recommended.

Stained glass and decorative paint

Stained glass paint and decorative paint is applied directly to the brush on different materials, these paints adhere to the smoothest surfaces such as glass, plexiglass, porcelain and metals. Stained glass paint gives the effect of transparency and with the decorative paint we get very good opacity.

All the above-mentioned paints are water-based, non-toxic and washable.





A Tempera Blocks

School quality, economical tempera blocks. 57 mm in diameter, 19 mm thick. Colour pigments compressed in a hard and dry block, that gradually dissolves upon contact with water. Sold in packs of 6 blocks. Non toxic.

Black (20)	5 ⁹⁵	1250356
Bright green (14)	5 ⁹⁵	1250448
Bright red (5)	5 ⁹⁵	1250380
Brilliant blue (9)	5 ⁹⁵	1250232
Brilliant yellow (3)	5 ⁹⁵	1250315
Burnt sienna (17)	5 ⁹⁵	1250414
Burnt umber (18)	5 ⁹⁵	1250406
Crimson (6)	5 ⁹⁵	1250281
Emerald green (15)	5 ⁹⁵	1250455
Grey (19)	5 ⁹⁵	1250299
Leaf green (13)	5 ⁹⁵	1250463
Lemon (2)	5 ⁹⁵	1250323
Orange (4)	5 ⁹⁵	1250364
Peach (16)	5 ⁹⁵	1250372
Pink (8)	5 ⁹⁵	1250398
Purple (7)	5 ⁹⁵	1250349
Sky blue (10)	5 ⁹⁵	1250240
Turquoise (12)	5 ⁹⁵	1250422
Violet (11)	5 ⁹⁵	1250497
White (1)	5 ⁹⁵	1250224



Tempera Paint Block Trays

B Empty Tray	3 ¹⁵	1141134		
C Primary Colours Tray				
White, blue, yellow, black, red, green.	12 ⁹⁵	1253558	G Skin Colours Tray	12 ⁹⁵ 1253574
D Refill for Primary Colours Tray	6 ³⁰	1255454	H Refill for Skin Tone Colours Tray	6 ³⁰ 1255470
E Secondary Colours Tray			I Stéphane's Set	
Mauve, orange, sienna, turquoise, viridian, violet.	12 ⁹⁵	1253566	B&B tray with 8 ø 57 mm tempera blocks: primary colours (3), secondary colours (3), black and white.	13 ⁹⁵ 1250885
F Refill for Secondary Colours Tray	6 ³⁰	1255462	J Refill for Stephane's Set Colours Tray	8 ⁴⁰ 1255488

Tempera



A B&B Washable Tempera

B&B liquid tempera is a water-based paint, cost-efficient and of exceptional quality. Ready to use, it is offered in a wide range of colours and in 3 formats. Washable and non-toxic.

	500 ml	1 l	3 6 l
Black	1243641	1243526	1243401
Brown	1243666	1243542	1243427
Cyan blue	1243658	1243534	1243419
Dark blue	1243732	1243617	1243492
Dark green	1243674	1243559	1243435
Light green	1243682	1243567	1243443
Magenta	1243690	1243575	1243450
Orange	1243708	1243583	1243468
Purple	1243716	1243591	1243476
Red	1243724	1243609	1243484
White	1243740	1243625	1243500
Yellow	1243757	1243633	1243518
	3⁵⁵	5⁶⁰	16⁹⁵

B Demco Finger Paint

Thick tempera, usually applied with the hands or fingers on a preferably glossy support. Non toxic and gluten-free.

	500 mL	1 L
Black	1262294	1262393
Blue	1262260	1262369
Brown	1262278	1262377
Green	1262336	1262435
Orange	1262302	1262401
Red	1262310	1262419
Violet	1262344	1262443
White	1262252	1262351
Yellow	1262286	1262385
	3⁵⁰	5³⁰

C Demco Tempera

Ready-to-use liquid tempera. Good opacity. Non-toxic. Sold individually.

	500 mL	1 L	3 6 L
Black	1266659	1266733	1266774
Brown	1266220	1266469	1266584
Carmine	1266162	1266402	1266527

Cyan blue	1266667	1266741	1266782
Dark blue	1266188	1266428	1266543
Dark green	1266212	1266451	1266576
Light blue	1266196	1266436	1266550
Light green	1266204	1266444	1266568
Magenta	1266238	1266477	1266592
Orange	1266147	1266386	1266501
Scarlet	1266154	1266394	1266519
Violet	1266170	1266410	1266535
White	1266642	1266725	1266766
Yellow	1266139	1266378	1266493
	3⁹⁰	5⁸⁵	17⁹⁵

D Demco Fluorescent Tempera

Ready-to-use liquid tempera. Good opacity. Non-toxic. Fluorescent colours. 237 mL.

Blue	4⁴⁰	1256163
Green	4⁴⁰	1256213
Orange	4⁴⁰	1256189
Pink	4⁴⁰	1256197
Red	4⁴⁰	1256205
Yellow	4⁴⁰	1256171



A Corello+ Tempera BB

Ready-to-use liquid tempera. Good opacity and bright colours. Non-toxic. Especially suitable for early childhood, recommended for preschool and elementary levels. Bright colours. Velvety smooth finish. Teachers' first choice. Sold individually.

	500 mL	1 L	3 6 L
Black	1253798	1253897	1253996
Brown	1253772	1253871	1253970
Cyan blue	1253764	1253863	1253962
Dark blue	1253822	1253921	1254028
Green	1253830	1253939	1254036
Light green	1254283	1254267	1254309
Magenta	1254085	1254101	1254127
Orange	1253806	1253905	1254002
Peach	1253400	1253426	1253442
Primary yellow	1253780	1253889	1253988
Red	1253814	1253913	1254010
Turquoise	1253418	1253434	1253459
Violet	1253848	1253947	1254044
White	1253756	1253855	1253954
	4⁶⁰	7⁵⁵	23⁹⁵

B Corello Tempera Basic Colours

Set of 6 bottles of liquid ready to use tempera. Blue, yellow, orange, red, green and purple. Non toxic. 120 ml each.

16⁹⁵ 1255439

C Corello Tempera Complementary Colours

Set of 6 bottles of liquid ready to use tempera. Black, white, cyan, gold, silver and copper. Non toxic. 6 x 120 ml.

16⁹⁵ 1255447

D Metallic Corello+ Tempera

Ready-to-use liquid tempera. Non-toxic. Metallic colours. 473 mL.

Blue	5⁹⁵	1254259
Copper	5⁹⁵	1253384
Gold	5⁹⁵	1253392
Green	5⁹⁵	1254564
Red	5⁹⁵	1254192
Silver	5⁹⁵	1253376

E Corello+ Metallic Tempera

Liquid tempera paint with metallic glints. Non toxic. Set of 6 brilliant colours. 6 x 120 mL.

13⁹⁵ 1252154

Tempera



A Miracolor Tempera

Exceptionally vivid, ready-to-use colours. Non-toxic. Good hiding power. Easy to use in school settings. Its three primary colours have been formulated to offer the largest range of mixing possibilities.

	500 mL	1 L	2 L
Black	1254937	1255058	1255173
Brown	1254879	1254994	1255116
Cyan	1254887	1255009	1255124
Green	1254960	1255082	1255207
Magenta	1254929	1255041	1255165
Orange	1254945	1255066	1255181
Primary yellow	1254911	1255033	1255157
Scarlet	1254895	1255017	1255132
Ultramarine	1254952	1255074	1255199
Violet	1254978	1255090	1255215
White	1254861	1254986	1255108
	9⁹⁵	17⁹⁵	29⁹⁵

Miracolor Tempera

Set of 5 containers (2 L). Cyan blue, magenta, primary yellow, black, white. Non toxic.

137⁹⁵ 1254853

B Vernicolor Water-based Varnish

Specifically formulated to varnish tempera work. Water-based, to add brightness and durability to colours. Dries in 15 minutes with a shiny finish. Non-toxic and washable. Clean brushes with soap and water after use.

250 mL	10⁹⁵	1201730
500 mL	18⁹⁵	1205939
1 L	36⁹⁵	1206465

C Dispensing Caps

ø 24 mm
Set of 20 dispensing caps for 237 mL PET bottles, with ø 24 mm bottleneck. **5⁹⁵** 1210301

ø 28 mm
For 500 mL and 1 L bottles. Set of 20. **5⁹⁵** 1210319

Hint from B²

To avoid the tempera paint from drying inside the mechanism, insert a pipe cleaner into the opening of the pump.

D All-Purpose Pump Dispenser

This pump adjusts to all 2 l and 3.6 l bottles. Use with all liquid and semi-liquid products such as: CORELLO Tempera – 3.6 l bottles, DEMCO Tempera – 3.6 l bottles, White glue – 3 l bottles.

4²⁵ 1380245

A



A B&B Acrylic

Permanent and non-toxic. Can be used like regular tempera, since all the colours can be mixed together and diluted with water.

	118 mL	500 mL	2 L
Black	1255694	1259035	1259423
Bright green	1254507	1259027	1259415
Brilliant red	1255629	1258961	1259357
Burnt Sienna	1254515	1254531	1254556
Cyan	1255579	1258904	1259290
Dark green	1255678	1259019	1259407
Magenta	1255587	1258912	1259308
Ochre yellow	1254499	1259050	1259449
Orange	1255611	1258953	1259340
Primary yellow	1255595	1258920	1259316
Prussian blue	1255660	1258995	1259381
Titanium white	1255728	1259068	1259456
Ultramarine	1254481	1254523	1254549
Violet	1255645	1258987	1259373
	4⁹⁵	9⁸⁰	34⁹⁵

B B&B High Viscosity Acrylics

In addition to its thick consistency and smoothness, this acrylic is highly pigmented and is permanent once dry. High viscosity acrylics can be diluted or used as is for impasto techniques. They can also be applied to any porous surfaces. Non toxic.

Complete set

Titanium white, Mars black, natural Sienna, primary yellow, primary cyan and primary magenta. 6 x 473 ml. **51⁹⁵** 1256015

473 mL

Cyan	9⁹⁵	1256288
Magenta	9⁹⁵	1256296
Mars black	9⁹⁵	1256304
Sienna	9⁹⁵	1256312
Titanium white	9⁹⁵	1256320
Yellow	9⁹⁵	1256270

1 litre

Titanium white	17⁹⁵	1256221
----------------	------------------------	---------

B&B Acrylic – 5 x 2 Litres Set

Permanent and non-toxic. Can be used like regular tempera, since all the colours can be mixed together and diluted with water. Black, magenta, titanium white, primary yellow and cyan. Not shown.

147⁹⁵ 1251065

B BB B²



C BB



C B&B Acrylic Set tubes

Available in sets of 5 or 10 – 118 mL tubes. Non toxic.

5 Tubes Set

Yellow, bright red, blue, white and black.

22⁹⁵ 1259464

10 Tubes Set

Assorted colours.

43⁹⁵ 1250000

Acrylic

A



B



C



D



A Studio Acrylic

This thick high-viscosity acrylic is particularly well-suited for dimensional work and retains brush or spatula marks. It is guaranteed free of environmentally harmful heavy metals. 250 mL.

Burnt Sienna (38)	1004720
Cadmium green (43)	1004738
Cadmium orange (32)	1004746
Cadmium red (33)	1004712
Dark ultramarine blue (15)	1004639
Mars black (26)	1004688
Natural umber (64)	1004704
Ochre yellow (27)	1004696
Oriental purple (21)	1004613
Phthalocyanine emerald (42)	1004654
Primary cyan (49)	1004647
Primary magenta (50)	1004670
Primary yellow (48)	1004662
Titanium white (11)	1004621

10⁹⁵

B Studio Acrylic – Metallic Colours

Bright colours and deep, richly pigmented, satin matt finish, very good lightfastness. Very adherent and indelible once dry, suitable for most surfaces. Can be mixed together. Applied with a brush, it can be used for fine, regular lines, glaze effects and watercolour effects. It is guaranteed free of environmentally harmful heavy metals. 100 mL tubes.

Iridescent Gold 352	6⁷⁰	1004423
Iridescent Copper 355	6⁷⁰	1004340
Iridescent Silver 351	6⁷⁰	1004316

C Demco Neon Acrylic

High viscosity acrylic with excellent opacity. Versatile, it can be used with a variety of media: cardboards, canvas, wood, fabrics. All colours can be mixed together. Easy clean with soap and water. 120 ml tube with flip top.

Neon Blue	1255546
Neon Green	1255553
Neon Orange	1255520
Neon Pink	1255512
Neon Red	1255538
Neon Yellow	1255504

5³⁰

D Liquitex Basics Acrylic

Basics acrylic offers a wide range of intense permanent opaque colors. Easy to use, perfect for beginners. Water-resistant, it stays flexible when dry. All colors can be mixed together and diluted in water, or with any medium. Suitable for most non-greasy surfaces. Non-toxic, suitable for children. Dries within 30 min. Clean brushes with soapy water. 250 mL tubes.

Bright Aqua Green	1002914
Burnt Sienna	1002930
Burnt Umber	1002948
Cadmium Orange Hue (imit.)	1002955
Cadmium Red Deep Hue (imit.)	1002963
Cadmium Red Light Hue (imit.)	1002971
Cadmium Red Medium Hue (imit.)	1002989
Cadmium Yellow Deep Hue (imit.)	1002997
Cadmium Yellow Light Hue (imit.)	1003003
Cadmium Yellow Medium Hue (imit.)	1003011
Cerulean Blue Hue (imit.)	1003029
Cobalt Blue Hue	1003037
Dioxazine Purple	1003045
Ivory Black	1003052
Light Green Permanent	1003060
Mars Black	1003086
Neutral Gray Value 5	1003144
Phthalocyanine Blue	1003151
Phthalocyanine Green	1003169
Quinacridone Magenta	1003177
Raw Sienna	1003201
Titanium White	1003367
Ultramarine Blue	1002922

12⁹⁵

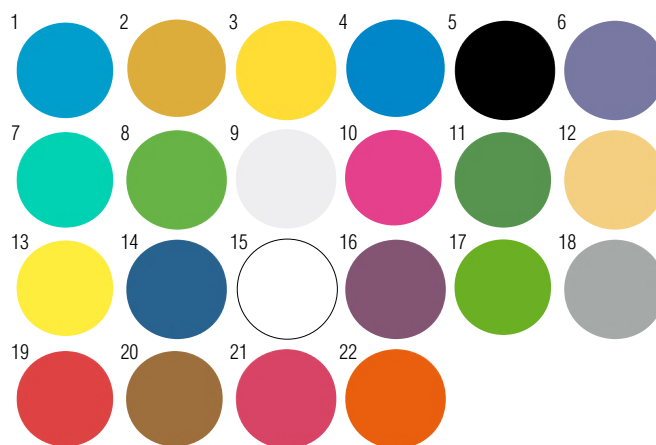

A Water-based spray paint

Water-based paint with a matte finish. The formula combines water-soluble resins with low odour and high quality pigments. Definitely fixed after about 20 minutes, but still allows the immediate superposition to the bomb of different shades without mixing. Once dried the paint is 100% durable and water resistant. For indoors and outdoors use. The paint components are eco-friendly and come exclusively from Europe. 300 ml.

Azo Orange (22)	12⁹⁵	1241975
Brilliant Green (11)	12⁹⁵	1242072
Brilliant Light Green (17)	12⁹⁵	1242064
Cadmium Yellow Medium (3)	12⁹⁵	1242197
Carbon Black (5)	12⁹⁵	1242122
Cerulean Blue (4)	12⁹⁵	1242031
Cobalt Blue (14)	12⁹⁵	1242049
Deep Blue Violet (16)	12⁹⁵	1242015
Dioxazine Purple (6)	12⁹⁵	1242023
Fluorescent Blue (1)	12⁹⁵	1242163
Fluorescent Green (8)	12⁹⁵	1242155
Fluorescent Magenta (10)	12⁹⁵	1242148
Fluorescent Yellow (13)	12⁹⁵	1242130
Gold (12)	12⁹⁵	1242171
Naphthol Red (19)	12⁹⁵	1241983
Naples Yellow (2)	12⁹⁵	1242080
Neutral Grey (18)	12⁹⁵	1242106
Quinacridone Magenta (21)	12⁹⁵	1241991
Raw Sienna (20)	12⁹⁵	1242098
Silver (9)	12⁹⁵	1242189
Titanium White (15)	12⁹⁵	1242114
Turquoise Green (7)	12⁹⁵	1242056

B Liquitex Acrylic Markers

Professional quality water-based permanent acrylic paint markers. Highly pigmented. Available in 2 mm or 15 mm nibs. The 15 mm nib produces a line of 8 to 15 mm. Durable and versatile, these markers can be used on a wide range of surfaces. Ideal for large-scale artwork, indoor and outdoor murals, sketching, fine detail, mixed media. Can be used on its own with acrylic or varnish. Satin finish.

		2 mm	15 mm
Carbon black	1005016	1004092	
Titanium white	1005032	1004480	
	7¹⁰	10⁹⁵	

C Sharpie Poster Paint Markers

Water-based paint markers. Medium point. Per unit.

Black	3⁹⁰	1310044
Blue	3⁹⁰	1310069
Gold	3⁹⁰	1310242
Green	3⁹⁰	1310077
Red	3⁹⁰	1310051
Silver	3⁹⁰	1310275
Yellow	3⁹⁰	1310085

D Sharpie Permanent Paint Markers

Oil-based markers, opaque colours, with excellent hiding power. Permanent. Medium tips. Per unit.

Black	3⁹⁰	1310283
Blue	3⁹⁰	1310309
Gold	3⁹⁰	1310366
Green	3⁹⁰	1310317
Orange	3⁹⁰	1310341
Purple	3⁹⁰	1310333
Red	3⁹⁰	1310291
Silver	3⁹⁰	1310374
White	3⁹⁰	1310358
Yellow	3⁹⁰	1310325

Acrylic Paint Markers

Permanent acrylic paint markers with chisel tip. Perfect for painting small wooden objects, plaster, paper, plastic and even metal. Non-toxic, acid-free and lead-free. Fast drying. Water-based formula.

E 4 Primary colours	16⁹⁵	1312065
F 4 Bright colours	16⁹⁵	1312073
G 4 Metallic colours	16⁹⁵	1312081

Acrylic Mediums



A B&B Polymer Varnish

Water-based, permanent varnish, used as a protective sealer. Can be used as a finishing coat on the painted surface. Excellent adhesive for collages. Non toxic.

	1 L	2 L	500 mL
Glossy	1261460	1261478	1261353
Matte	1200559	1200567	1200542
	17⁹⁵	29⁹⁵	10⁹⁵

B B&B Gloss Acrylic Medium

This medium enhances the transparency of a colour without affecting its consistency. A great product to achieve a high-gloss glazing. 500 mL.

16⁹⁵ 1261320

C Pouring Medium

Fluid, and transparent, it remains glossy and maintains its wet appearance when dry. Poured on sheets, it is even possible to create "puddles" and flowing applications of colour. Flexible, non-yellowing and water resistant when dry, it does not bubble on the paint when dry and adds no transparency when mixed with colour. 1 L

26⁹⁵ 1255496

D Crackling Medium

Easy-to-use medium for a crackled finish. Clean with water. 118 mL bottle.

6¹⁰ 1260801

E Liquitex Matte Medium

Liquitex mediums can be used with colours in either jars or tubes.

473 mL	27⁹⁵	1008010
946 mL	38⁹⁵	1008028
3.79 L	87⁹⁵	1008036

F Glossy Liquitex Polymer Medium

Liquitex mediums can be used with colours in either jars or tubes.

473 mL	27⁹⁵	1009265
946 mL	38⁹⁵	1009273
3.79 L	87⁹⁵	1009281

G Liquitex Retarding Medium

237 mL pot.

16⁹⁵ 1009711



A B&B Gesso

Pure acrylic emulsion used as primer coat for all surfaces. Water resistant once dry. Flexible, non-yellowing.

500 mL	8¹⁵	1200526
1000 mL	13⁹⁵	1200518

B B&B Student Grade Gesso

Student quality pure acrylic emulsion used as primer coat for all surfaces. Water resistant once dry. Flexible, non-yellowing. Wash brushes with water and soap after use. Can be diluted in a small quantity of water.

948 mL	10⁹⁵	1209881
36 L	38⁹⁵	1230127

C Mod Podge

All-in-one sealer, glue and finish. Ideal for cutting and decorating projects. Gives a polished finish. Non-toxic.

237 mL	8⁷⁰	1200575
473 mL	12⁹⁵	1203645
946 mL	24⁹⁵	1203751

D Liquitex Gesso

Liquitex mediums can be used with acrylics in either jars or tubes.

946 mL	38⁹⁵	1007632
3.79 L	88⁹⁵	1007640

E Liquitex Gloss Gel

Liquitex mediums can be used with acrylics in either jars or tubes.

473 mL	26⁹⁵	1007590
946 mL	37⁹⁵	1007608

F Liquitex Modelling Paste

Liquitex mediums can be used with colours in either jars or tubes.

473 mL	24⁹⁵	1008903
946 mL	37⁹⁵	1008911
3.79 L	89⁹⁵	1008929



A Ecoline Liquid Watercolour

Good adhesion on paper and board, and is versatile enough for traditional brush, sprayed through airbrush, or used with drawing/technical pens. Jar includes a pipette built into the cap for easy application.

- Set of 5 primary colours. 30 mL. **32⁹⁵** 1241926
- Set of 10 colours. 30 mL. **64⁹⁵** 1241934

B Aquatint Indian ink B&B

Developed by Brault & Bouthillier, Aquatint ink is a very deep black ink easily diluted with water to produce reserve processes. Offers an excellent hiding power and can also be used pure.

- 60 mL **2⁹⁰** 1244805
- 237 mL **5¹⁰** 1244813
- 1000 mL **15⁹⁵** 1244821

C Demco Drawing Ink

60 mL bottles.

- Blue **5⁷⁰** 1240654
- Brown **5⁷⁰** 1240456
- Green **5⁷⁰** 1240738
- Orange **5⁷⁰** 1240704
- Purple **5⁷⁰** 1240753
- Red **5⁷⁰** 1240712
- White **5⁷⁰** 1240647
- Yellow **5⁷⁰** 1240670

D Colorex Drawing Ink

Bright and intense coloured ink. Very concentrated, Colorex watercolour ink can be diluted to an extreme degree. Its transparency makes it suitable for colour layering, while the three primary colours can be combined to explore the richness of the colour mixing possibilities. 250 mL.

- Cyan **16⁹⁵** 1241553
- Ivory black **16⁹⁵** 1241306
- Magenta **16⁹⁵** 1241579
- Primary yellow **16⁹⁵** 1241561
- Sepia **16⁹⁵** 1241025
- Ultramarine Blue **16⁹⁵** 1241942
- Vermillion **16⁹⁵** 1241959
- Vert lumière **16⁹⁵** 1241967
- White **16⁹⁵** 1240498

E Colorex Drawing Ink

Bright and intense coloured ink. Very concentrated, Colorex watercolour ink can be diluted to an extreme degree. Its transparency makes it suitable for colour layering, while the three primary colours can be combined to explore the richness of the colour mixing possibilities. 45 mL.

- Gold **8⁰⁵** 1240357
- Silver **8⁰⁵** 1240340

F Colorex Drawing Ink Sets

- 5 colours**
Primary yellow, magenta, cyan, white, ebony black. **42⁹⁵** 1240779
- 10 Colours**
Lemon yellow, vermilion, turquoise, yellow green, moss green, parma, yellow ocher, sepia, ivory black, ultramarine. **65⁹⁵** 1240787

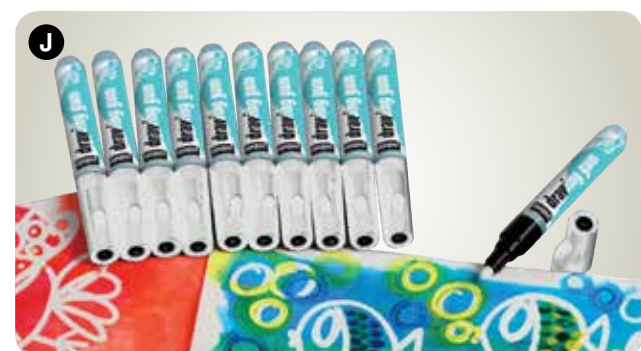
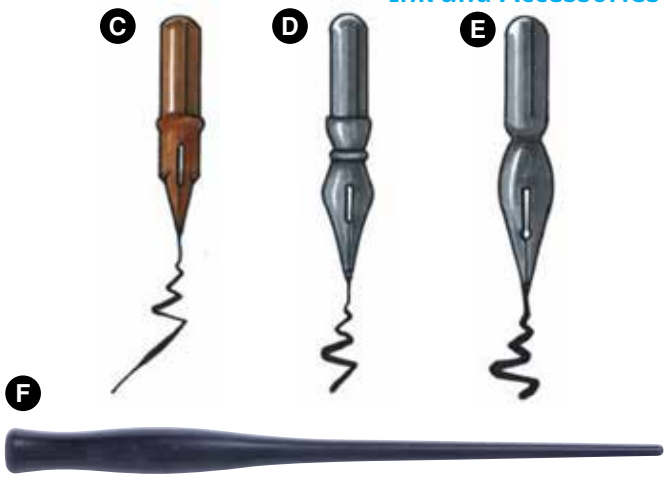

A Indian Ink in Block

The ink in block form produces a pure and intense black, as well as all shades of grey. Directions: place a few drops of water and dip the end of a paintbrush to load it with ink. In a plastic box.

3⁵⁰ 1247014

B Indian Ink Brush Pen

Beautiful Indian ink brush pen with fine silk bristles. A single brush stroke produces fine or thick lines. Ideal for painting, sketching and detail work. Very handy for outdoors work. Comes with 4 refill cartridges.

Indian Ink Brush Pen **16⁹⁵** 1311232
 Indian Ink Brush Pen Refill **7⁶⁵** 1311240

C Student Drawing Pens

Fine point nib. Box of 12.

15⁹⁵ 1411859

D Drawing Pens

Extra fine point nib. Box of 12.

15⁹⁵ 1411891

E Lettering Pens

Extra fine point nib. Box of 12.

15⁹⁵ 1411909

F Speedball Penholder

Plastic pen holder. Suitable for all Speedball pen nibs, as well as Speedball numbers 9406, 9412, 9413. Plastic.

1⁷⁰ 1412055

G Bamboo Pens

Perfect for drawing and writing.

Fine point nib **3²⁰** 1410760
 Medium point nib **3²⁰** 1410778
 Wide point nib **3²⁰** 1410786

H Pen and Penholder Set

8 lettering nibs and 2 penholders. Prod. 3065-5.

17⁹⁵ 1410570

I Pen Assortment

10 pens on a card. Prod. 3071.

25⁹⁵ 1410554

J Drawing Gum Markers

Its 4 mm round tip is ideal for drawing and detailing.

72⁹⁵ 1374487

K B&B Resigum Resist-Gum

RESIGUM is the medium liquid commonly used in conjunction with Colorex drawing inks, Indian ink or watercolours. RESIGUM is used to conserve areas on paper or cardboard, and can be easily applied with a pen or a paintbrush. Dries in 15 minutes. Simply remove by rubbing with fingers, without ripping the paper.

120 mL **9⁹⁵** 1201367
 237 mL **17⁹⁵** 1201375

Watercolour



A Pentel Watercolours in Tubes

Colours in 5 cc tubes. White in 7 cc tube.

12 colours **9⁴⁰** 1250141
18 colours **13⁹⁵** 1250158

B Tempera Paint Tray Set

Perfect for mixing, with 12 beautiful, opaque colours. Brush included.

6⁹⁵ 1250836

C Watercolour cups

Strong and highly transparent colours. All colours have uniform viscosity. Highly lightfast, even after strong dilution. Easy colour transfer.

12 Colours **8⁹⁵** 1252584
24 Colours **14⁹⁵** 1252469

Prang Semi-Moist Oval Watercolour Discs

Refillable, opaque plastic box with lid, which doubles as a palette. Includes brush.

D 8 colours **6⁶⁰** 1257674
E 16 colours **9⁹⁵** 1257682

F Prang Semi-Moist Watercolour Discs

Metallic colours. Box of 8 colours.

5⁰⁵ 1250018

G Brush Pens

Brush pens with a reservoir for liquid ink. Set of 3 brush pens with fine, medium and broad tips.

8⁰⁵ 1420389

→ 
Watercolor paper and
cardboard on page 374.



→ Acetate & plastic sheets see page 449



A Stained Glass Watercolours

Stained glass watercolours are translucent and may be applied with a paintbrush to any surface such as glass, acetate, plexiglass, aluminium, etc. Colours are miscible with one another. Relief paint is used to outline the pattern so as to form an enclosed area (cloisonné technique) as in stained glass techniques. Non-toxic. Clean brushes with water. 45 mL bottles.

Set of 10 colours	58⁹⁵	1233014
Black	5⁹⁵	1234160
Evergreen	5⁹⁵	1234426
Orange	5⁹⁵	1234178
Pink	5⁹⁵	1234186
Red	5⁹⁵	1234194
Spring green	5⁹⁵	1234202
Turquoise	5⁹⁵	1234137
Ultramarine	5⁹⁵	1234145
White	5⁹⁵	1234129
Yellow	5⁹⁵	1234152

B Pébéo Relief Outliner

20 mL tubes.		
Black	5⁶⁰	1230135
Gold	5⁶⁰	1230168
Lead grey	5⁶⁰	1234541
Silver	5⁶⁰	1230143



C Black Liquid Relief Outliner

118 mL bottle. **6⁶⁵** 1230051

D Arti'stick Stained Glass Outliners

Available in 3 colours and 2 sizes.		
	75 mL	500 mL
Black	1234061	1234392
Gold	1234079	1234400
Silver	1234103	
	4³⁰	13⁹⁵

E Arti'stick Repositionable Paints

Apply to a non-porous surface, peel away, position, and reposition again! Place on any smooth surface such as glass, plastic or ceramics. Apply colour to any plastic surface using the applicator tube. Let dry for 24 hours. Peel away and place on any smooth surface of your choice. 500 mL.

Black	13⁹⁵	1234319
Brown	13⁹⁵	1234293
Dark blue	13⁹⁵	1234251
Dark green	13⁹⁵	1234277
Gold sparkles	13⁹⁵	1234343
Light blue	13⁹⁵	1234269
Light green	13⁹⁵	1234285
Orange	13⁹⁵	1234228
Pink	13⁹⁵	1234244
Red	13⁹⁵	1234236
White	13⁹⁵	1234327
Yellow	13⁹⁵	1234210

F Group Set

Includes 10 – 500 mL bottles (1 black outliner, 1 gold outliner and all of the following colours: red, blue, green, white, yellow, salmon, violet, iridescent sequins), as well as 30 – 25 mL empty applicator bottles. **127⁹⁵** 1234582

Fabric and Porcelain Paint



B



C



A Pébéo Sétacolor Fabric Paint

Water-based, opaque colours, suitable for all types of fabrics. Colours are miscible in each other. Set colours simply by ironing on the wrong side of the fabric, once completely dry, using an iron set at "Cotton", for 2 to 5 minutes. Washable once colours are set.

250 mL bottles

Black	22 ⁹⁵	1031111
Cobalt Blue	22 ⁹⁵	1031038
Golden Yellow	22 ⁹⁵	1031103
Lemon Yellow	22 ⁹⁵	1031095
Vermillion	22 ⁹⁵	1031145
White	22 ⁹⁵	1031020

45 mL bottles

Red, yellow, blue, white and black.	27 ⁹⁵	1030741
-------------------------------------	------------------	---------

10 Colour Set

Lemon yellow, white, cobalt blue, vermillion black, purple, spring green, chocolate, raspberry and golden cup yellow.	59 ⁹⁵	1031194
---	------------------	---------

B Porcelain Paint

Porcelain paint is fixed by baking in a domestic oven at 325°F. Colours are miscible in each other. Superb enamelled appearance after baking. In 45 mL bottles or markers.

Set of 10 – 45 mL bottles.

69⁹⁵ 1230101

C Porcelain Paint Markers

Marker with normal tip.

Agath	6 ⁹⁵	3299963
Amazonite Green	6 ⁹⁵	3290640
Anthracite Black	6 ⁹⁵	3290657
Blue	6 ⁹⁵	3290632
Earth	6 ⁹⁵	3299997
Lapis	6 ⁹⁵	3299971
Peridot	6 ⁹⁵	3299989
Scarlet Red	6 ⁹⁵	3290624
Yellow	6 ⁹⁵	3290616



B



C



D



E



F



G



H



I



A Flying Colors paint spinner

Hand cranked wooden tray on which a plastic round tray is placed. After covering the bottom of the tray with a sheet of paper and applying paint, the crank is actuated and the tray spins, creating unique works by centrifugal force. Turning the handle quickly or slowly, influences the development of the image and ... fascinates the creators! A simple way to create expressive and dynamic works of art. Includes: 1 paint centrifuge, 1 plastic tray, 2 magnetic pencils for fixing.

224⁹⁵ 2037737

B Refill of 200 round sheets

Refill of 200 round sheets of 35 cm in ø. Not shown.

44⁹⁵ 2037745

C Plastic Cups with Lids

150 mL. Pack of 100.

57⁹⁵ 1140284

D Empty bottle with Applicator Cap

Plastic. 114 mL.

0⁹⁴ 1140201

E Empty Bottle with Snap Cap

Plastic. 228 mL.

1⁰⁰ 1141209

F Paper Containers

Fits the B&B 6 cavity tray (see 1141134). Pack of 250. ø 64 mm. 118 mL.

11⁹⁵ 1141233

G Plastic Paint Tray with Containers and Lids

Paint tray with 8 cavities, holding 8 plastic containers with lids. Rectangular, 33 x 18 cm. With 8 ø 7 cm cavities.

10⁹⁵ 1140268

H Plastic Paint Tray

Can hold 8 57-mm tempera blocks or be used as a palette. Rectangular 33 x 18 cm. With 8 ø 7 cm cavities.

5⁷⁵ 1140276

I Plastic Bowls

These sturdy plastic bowls are ideal for sorting, counting and stringing activities, manipulatives, small pegboards and pegs, linking cubes, pebbles, arts and crafts, and more. ø 13 cm x 4 cm deep. White. Pack of 12.

9⁹⁵ 2037398

Painting Accessories

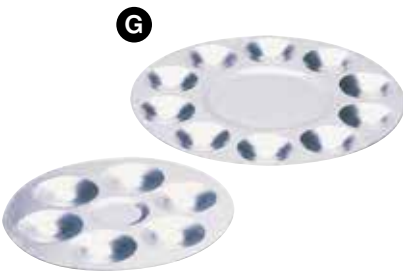

A Safety plastic containers with lid

200 mL capacity.

Pack of 10 **12⁹⁵** 1141175
Single Unit **1⁶⁵** 1141076

B Paint Tray for Safety Containers

Plastic paint tray with 6 cavities, designed to hold up to 6 safety plastic paint containers (not included). 20 x 30 x 7.5 cm.

9⁹⁵ 1141795

C Set of Jars with Holder

6 – 30 mL moulded jars, on a plastic base.

2¹⁰ 1141647

Plastic Palettes

Available round with or without lid, or rectangular without lid.

D Round

ø 17 cm with 10 cavities **1²⁰** 1140953

E Rectangular

13 cm x 8.5 cm. With 6 cavities **1²⁰** 1140961

F Round

ø 17 cm. With 10 cavities and cover **2⁷⁰** 1140979

G Round Aluminium Palettes

For tempera and watercolours.

6 cavities

ø 13.5 cm **2¹⁰** 1140565

10 cavities

ø 16.8 cm **3¹⁵** 1140573

H Plastic Palette

Large size rectangular palette, in sturdy plastic.

With 16 round and square cavities. 30.3 x 11.1 cm.

2⁹⁵ 1140300

I Tray for Paint Rollers

Soft and resistant plastic tray with 2 cavities, ideal for paint rollers up to 10 cm wide. 25.7 x 23 cm.

8³⁰ 1202126

J Paint Tray

Plastic tray with high edges to prevent spills. Ideal for finger paints, liquid tempera and a variety of arts & crafts projects. 30 x 40 x 2.5 cm.

8⁹⁵ 1141803

K Multipurpose Desktop Trays

Keep things neat and organized with this set of 4 stackable, ultra-sturdy plastic trays, in 4 bright colours. Ideal for math sorting activities, stringing beads, messy arts and crafts projects, sand writing, pegboards, and more. 40.5 x 30.5 x 3 cm deep.

23⁹⁵ 2037349

L Polystyrene Trays

Pack of 125. 23 x 28 cm.

22⁹⁵ 1205913



A Bowls

Set of 6 plastic bowls. Assorted colours. ø 15 cm.
8⁴⁰ 1206010

B Triple Water Container

Convenient water container with 3 connecting sections. 8 x 8 x 11.5 cm.
5⁸⁰ 1141779

C Plastic Water Container

Convenient for keeping pencils and brushes. Filled with water, can be used to wash brushes.
4⁶⁵ 1140912

D Paint Bellows

Plastic bellows used to spray liquid tempera. Set of 3.
9²⁵ 1203884

E Arti'stick Applicator Tubes

Set of 25 empty 25 mL applicator tubes.
18⁹⁵ 1234517

F Paint Pipettes

See-through plastic pipettes, 15 cm long. Pack of 12.
8²⁰ 1203876

G Sponge

120 x 260 x 75 mm
5³⁵ 1205210

H Cellulose Sponge

147 x 85 x 22 mm
3¹⁰ 1201227

I Soaker Chalkboard Sponges

Can be used dry or wet.
 140 x 66 x 43 mm **2¹⁰** 1205327
 155 x 98 x 43 mm **3⁸⁰** 1201284

J Paint Scrapers

Set of 7 scrapers in assorted designs and colours.
9³⁵ 1200310

K Junior Paint Spritzers

Children can create interesting and unexpected effects by using these spritzers to spray gouache or other paints on various substrates. Package of 5.
7⁹⁵ 1193002

L Paint Rollers

Set of 5, with various patterns and textures. 25 to 70 mm wide. Plastic handles. Paint tray 1202126 is ideal with these rollers.
11⁹⁵ 1420314

M Soft Paint Rollers

Foam rollers with plastic handle.
 25 mm **1⁶⁰** 1421536
 70 mm **1⁹⁰** 1421544

Paintbrush Care

It's one thing to purchase good quality paintbrushes, but it is equally important to take good care of them. Quality cleaning and proper storage are essential for good conservation. The cleaning method depends on the paint used and the nature of the bristles.

Watercolour and Tempera

For watercolour and tempera, it is best to use tap water to rinse away any colour residue in the bristles. If needed, mild hand soap can be used but must be thoroughly rinsed.

Acrylic

Acrylic paint becomes permanent when it is dry. It is therefore important to immediately rinse the brushes after each painting session. It can sometimes be necessary to rinse the paintbrushes while painting, because acrylic paint dries very quickly.

Oil

Oil paint is cleaned using solvents such as turpentine oil or taltine solvent. After cleaning, brushes must be thoroughly washed in soapy water to remove any trace of solvent which could burn the fibres after prolonged exposure.

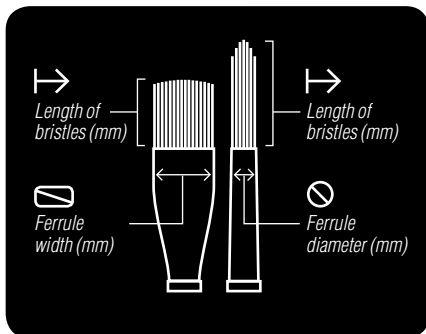

The following image illustrates the various features of our paintbrushes. The symbols illustrated repeat on the following pages as a reference to help you with your choice.



Paintbrushes should dry on a flat surface, or in a stand

Finally, it is important to never leave paintbrushes to soak in liquid for an extended period of time, which will crush and flatten the bristles. Furthermore, moisture causes the handles to expand and their varnish to crack.



See the spiral paint brush stand and filter on page 333 (1201698)





Hint from B²

Sets created by our specialists.



A B&B Preschool Brush Set

Set of 30 brushes with carrying tubes
 14 round brushes 195-08 (1427681)
 10 flat hog-bristle brushes 855-12 (1428697)
 6 flat hog-bristle brushes 855-18 (1428713)
 And 3 carrying tubes

68⁹⁵ 1421874

B B&B Elementary School Brush Set

Set of 30 brushes with carrying tubes
 10 flat hog-bristle brushes 855-14 (1428705)
 5 flat brushes 193-08 (1427962)
 5 flat brushes 193-12 (1427988)
 5 round brushes 195-06 (1427673)
 5 round brushes 195-10 (1427905)
 3 carrying tubes

72⁹⁵ 1421882

C B&B High School Brush Set

Set of 30 brushes with carrying tubes
 10 flat hog-bristle brushes 1329-08 (1428457)
 5 flat brushes 483-04 (1428226)
 5 flat brushes 483-12 (1428242)
 5 round brushes 485-08 (1428184)
 5 round brushes 485-12 (1428192)
 2 carrying tubes

79⁹⁵ 1421858

D B&B economical 36 Piece Long Handle Paint Brush Set

- Ideal for high school and college art classes
- 12 bristle brushes, 6 round and 6 flat. For gouache, acrylic and oil
- 12 goat hair brushes, 6 round and 6 flat. For ink, watercolour and other very fluid mediums
- 12 nylon brushes, 6 round and 6 flat. For fluid acrylic, watercolour and gouache
- Stored in a canvas pouch

24⁹⁵ 1423284





A

B

C

D

E

A Eterna Brushes – Series 577

Flat, hog bristle brushes, short handle, aluminium ferrule.

PROD.			CODE
577-04	6	0⁴⁷	1422286
577-06	7	0⁵¹	1422336
577-08	9	0⁶³	1422252
577-10	10	0⁶⁷	1422302
577-12	12	0⁷⁶	1422237
577-14	14	0⁹²	1422260
577-16	16	1¹⁵	1422278
577-18	19	1⁵⁰	1422310
577-20	21	1⁷⁵	1422328

B Eterna Brushes – Series 579

Flat, hog bristle brushes, long, painted, varnished handle, aluminium ferrule.

PROD.			CODE
579-02	6	0³⁰	1424290
579-04	8	0³³	1422294
579-06	11	0⁴⁸	1423326
579-08	14	0⁵⁶	1424415
579-10	18	0⁹⁶	1422245
579-12	23	1²⁰	1422492

C Eterna Brushes – Series 582

Round, hog bristle brushes, long, painted, varnished handle, aluminium ferrule.

PROD.			CODE
582-01	3	0⁴¹	1422054
582-02	4	0⁴³	1424944
582-03	5	0⁵⁸	1424936
582-04	6	0⁵⁸	1424530
582-05	7	0⁶⁵	1422062
582-06	8	0⁶⁹	1424902
582-08	10	0⁸⁰	1425370
582-10	12	0⁹⁰	1422351
582-12	16	1¹⁵	1425446

D Flat Brushes – Series 855

Flat brushes with hog bristles. Ideal for gouache and handcrafts. 160 mm handle, aluminium ferrule.

PROD.				CODE
855-2	7	12	1¹⁵	1428663
855-8	11	20	1⁵⁵	1428671
855-10	13	22	1⁸⁰	1428689
855-12	16	26	2¹⁰	1428697
855-14	17	30	2⁵⁰	1428705
855-18	23	31	2⁸⁰	1428713
855-20	25	37	3⁶⁰	1428721

E Round Brushes – Series 8010

Round brushes hog bristles. Ideal for gouache and handcrafts. 145 mm handle, aluminium ferrule.

PROD.				CODE
8010-8	3	14	1⁴⁰	1428739
8010-12	4	20	1⁶⁵	1428747
8010-16	5	25	1⁹⁵	1428754
8010-20	6	27	2¹⁰	1428762
8010-24	7	29	2²⁰	1428770

Ferrule diameter (mm)
 Ferrule width (mm)
 Length of bristles (mm)



A B&B

B B&B

C

D

A Flat Brushes – Series 1329

Bright brushes made with beaux-blanc quality bristles. Ideal for acrylics, oils and all thicker mediums. 264 mm handle long B&B blue stain and clear varnish. Nickel plated brass ferrule.

PROD.	⌀	↳		CODE
1329-2	5	9	1³⁵	1428424
1329-4	8	12	1⁸⁰	1428432
1329-6	11	15	2¹⁵	1428440
1329-8	17	23	2⁸⁰	1428457
1329-10	22	28	3⁴⁰	1428465
1329-12	29	35	3⁹⁵	1428473

B Dome Round Brushes – Series 2329

Round brushes made with beaux-blanc quality bristles. Ideal for acrylics, oils and all thicker mediums. 264 mm handle long B&B blue stain and clear varnish. Nickel plated brass ferrule.

PROD.	⌀	↳		CODE
2329-2	3	8	1³⁵	1428481
2329-4	4.5	12	1⁹⁵	1428499
2329-6	6	18	2¹⁵	1428507
2329-8	7.5	20	2⁷⁰	1428515
2329-10	9	25	3¹⁰	1428523
2329-12	12	32	3⁶⁵	1428531

C Stencil Brushes – Series 401

White, hog bristles.

PROD.		CODE
401-3	1³⁵	1424571
401-6	2³⁵	1424605

D All-purpose Brushes – Series 519

Pure silk bristles, wooden handle, aluminium ferrule.

25	1⁸⁰	1426972
50	2⁷⁰	1426998

E B&B Bamboo Brushes

Round paintbrushes with long, supple bristles and bamboo handles, for watercolours and inks.

PROD.	⌀	↳		CODE
B&B 0	3	15	3⁵⁰	1420173
B&B 2	4	20	3⁸⁰	1420199
B&B 4	6	24	4⁹⁵	1420215
B&B 6	8	34	6²⁵	1420231

F Round Brushes – Series 309

Round brushes with natural sable bristles. Ideal for all aqueous mediums: watercolor, ink, gouache and acrylic. 145 mm handle. Nickel plated brass ferrule.

PROD.	⌀	↳		CODE
309-3/0	1.8	8	2⁸⁰	1428374
309-2/0	2	9	4²⁵	1428382
309-0	2.3	10	5⁶⁰	1428390
309-1	2.5	11	7⁰⁵	1428408
309-4	3.2	17	9⁹⁰	1428416

G Round Brushes – Series 8314

Round brushes with pony bristles. Ideal for all aqueous mediums: watercolor, ink, gouache and acrylic. 145 mm handle. Aluminium ferrule.

PROD.	⌀	↳		CODE
8314-1	1.5	10	0⁹⁸	1428614
8314-2	2	11	1⁰⁵	1428622
8314-3	2.5	12	1¹⁵	1428630
8314-4	3	13	1³⁵	1428648
8314-6	4	16	1⁸⁰	1428655

E B&B

F B&B

G B&B





A

B

C

D

E

F

G

A Round Brushes—Series 195

Round brushes with synthetic bristles. Ideal for all aqueous mediums, watercolor, tempera, ink and acrylic. 145 mm short handle. Gold aluminium ferrule.

PROD.	⊙	↔		CODE
195-0	1.8	6	1³⁵	1427632
195-2	2.4	10	1⁵⁵	1427640
195-4	3	12	1⁹⁰	1427657
195-6	4	17	2¹⁰	1427673
195-8	4.9	19	2⁴⁵	1427681
195-10	6	22	3⁵⁰	1427905
195-12	6.5	26	4¹⁵	1427913

B Flat Brushes—Series 193

Flat brushes with white synthetic bristles. Ideal for all aqueous mediums, watercolor, tempera, ink and acrylic. 145 mm short handle. Gold aluminium ferrule.

PROD.	⊞	↔		CODE
193-0	2.7	5	1⁷⁰	1427921
193-2	3.3	6	1⁹⁰	1427939
193-4	4.1	8	1⁹⁵	1427947
193-6	6	10	2⁰⁵	1427954
193-8	6.7	12	2⁵⁵	1427962
193-10	7.2	14	3⁴⁵	1427970
193-12	9	16	3⁷⁰	1427988

C Round Brushes – Series 295

Round brushes with white synthetic medium-length bristles. Ideal for all aqueous mediums, watercolor, tempera, ink and acrylic. 145 mm short handle. Gold plated brass ferrule.

PROD.	⊙	↔		CODE
295-0	2	8	2⁵⁵	1427996
295-2	2.5	11.5	2⁷⁵	1428002
295-6	4.2	18	4¹⁰	1428010
295-10	7	25.5	5⁷⁰	1428028

D Flat Brushes – Series 293

Flat brushes with white synthetic short bristles. Ideal for all aqueous mediums: watercolor, tempera, ink and acrylic. 150 mm short handle. Gold plated brass ferrule.

PROD.	⊞	↔		CODE
293-1/8"	4	7.5	2⁷⁵	1428036
293-1/4"	7.4	10	3⁵⁰	1428044
293-1/2"	12.8	16.5	5⁴⁰	1428051
293-3/4"	19.5	20.5	7⁵⁰	1428069

E Fan Brushes – Series 296

Fan brush with white synthetic bristles. Ideal for all aqueous mediums: watercolor, tempera, ink and acrylic. Allows painting particular shapes and textures. 150 mm short handle. Gold plated brass ferrule.

PROD.	⊞	↔		CODE
296-2	35	16	4⁰⁵	1428077
296-4	40	19	6²⁵	1428085

F Flat Brushes – Series 294

Flat brush with white synthetic bristles. Ideal for all aqueous mediums: watercolor, tempera, ink and acrylic. The very long fibers allow regular lines and good control. 150 mm short handle. Gold plated brass ferrule.

PROD.	⊞	↔		CODE
294-1/4"	7.4	20	4¹⁵	1428093
294-1/2"	12.5	27.5	6⁰⁵	1428101
294-3/4"	19.5	32.5	8²⁵	1428119

G Round Liner Brushes – Series 292

Round liner brushes with white synthetic bristles. Ideal for all aqueous mediums: watercolor, tempera, ink and acrylic. Its shape is made to draw long lines. 150 mm short handle. Gold plated brass ferrule.

PROD.	⊙	↔		CODE
292-5/0	1.8	9	2²⁰	1428127
292-0	2	11	2⁵⁰	1428135
292-2	2.2	13	2⁷⁰	1428143

⊙ Ferrule diameter (mm)
 ⊞ Ferrule width (mm)
 ↔ Length of bristles (mm)



A Round Brushes – Series 485

Round brushes with gold synthetic bristles. Ideal for all aqueous mediums: aquarelle, tempera, ink and acrylic. 145 mm short handle. Silver aluminium ferrule.

PROD.	⌀	↔		CODE
485-0	1.8	4	2⁷⁵	1428150
485-2	1.8	6	3¹⁵	1428168
485-6	2.5	9	3⁵⁵	1428176
485-8	2.7	12	3⁷⁰	1428184
485-12	3.2	15	5⁴⁰	1428192
485-14	4	17	6⁹⁵	1428200

B Long Flat Brushes – Series 483

Long flat brushes with gold synthetic bristles. Ideal for all aqueous mediums: watercolor, tempera, ink and acrylic. 145 mm short handle. Silver aluminium ferrule.

PROD.	▭	↔		CODE
483-0	2.5	5	2⁷⁵	1428218
483-4	3.5	7	3¹⁵	1428226
483-8	6.7	12	4¹⁵	1428234
483-12	10.1	15	6³⁵	1428242
483-18	13.5	22	8²⁰	1428259

C Round Brushes – Series 495

Round brushes with gold synthetic bristles. Ideal for all aqueous mediums: watercolor, tempera, ink and acrylic. 150 mm short handle. Matt black lacquered aluminium ferrule.

PROD.	⌀	↔		CODE
495-0	2	9	2⁵⁰	1428267
495-2	2.4	11	2⁷⁵	1428275
495-4	3.2	15	3⁷⁵	1428283
495-8	6	22	5⁹⁵	1428291

D Liner Brushes – Series 492

Round liner brushes with golden synthetic bristles. Ideal for all aqueous mediums: watercolor, tempera, ink and acrylic. Made to draw long lines. 150 mm short handle. Matte finish black lacquered aluminium ferrule.

PROD.	⌀	↔		CODE
492-2	2.3	24	2⁷⁵	1428309
492-4	2.6	26	3⁶⁵	1428317
492-6	4	30	4²⁰	1428325

E Long Flat Brushes – Series 493

Long round flat brushes with gold synthetic bristles. Ideal for all aqueous mediums. Offers a good precision. 150 mm handle. Matte finish black lacquered aluminium ferrule.

PROD.	▭	↔		CODE
493-1/8"	4	17	3⁴⁵	1428333
493-1/4"	7.5	20	4²⁵	1428341
493-1/2"	1.5	26,5	8²⁰	1428358
493-3/4"	19.5	32,5	12⁹⁵	1428366

⌀ Ferrule diameter (mm)
 ▭ Ferrule width (mm)
 ↔ Length of bristles (mm)

Brushes

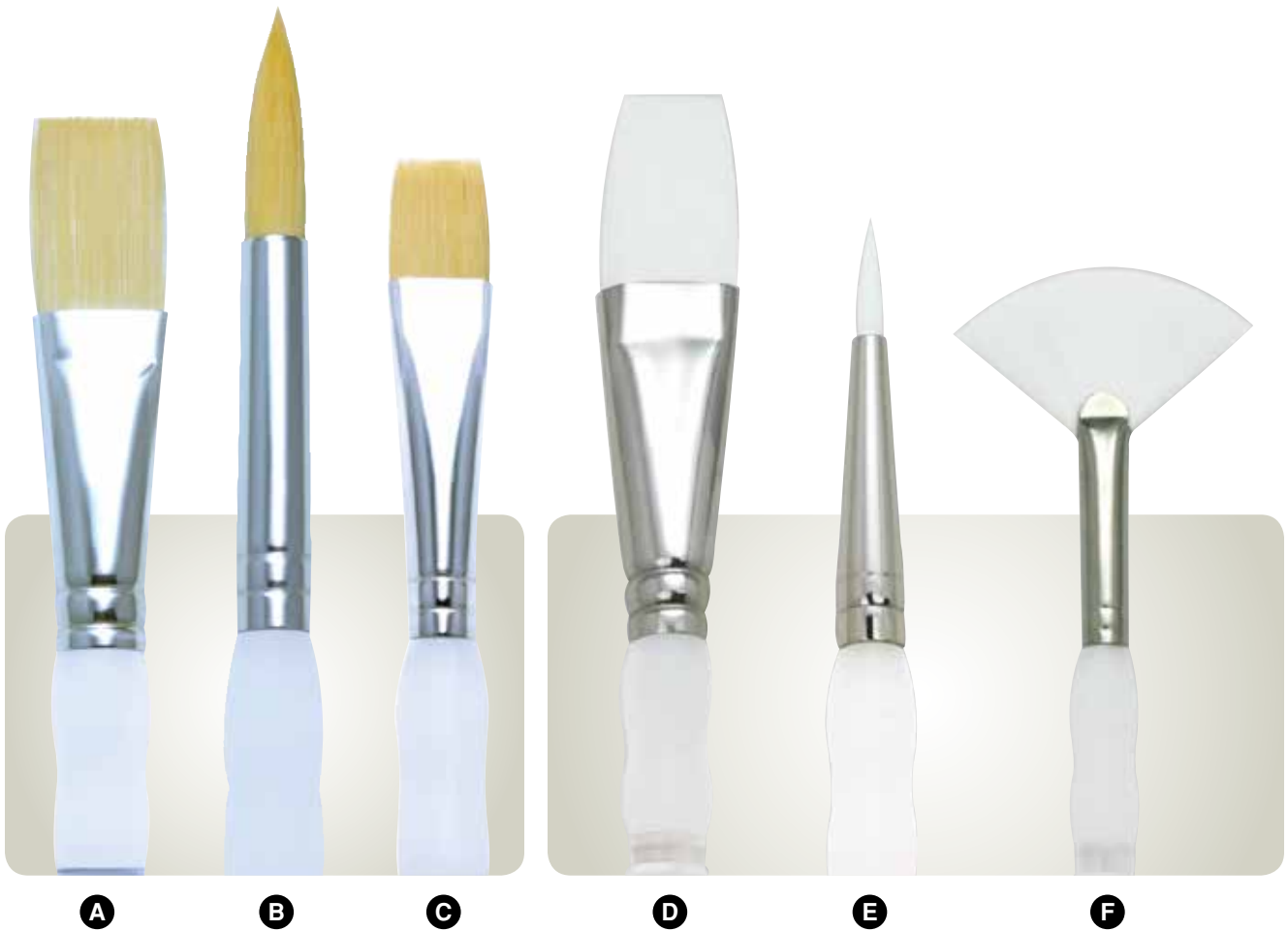

A Soft Grip Brushes™ – Series 711

Extra-long flat brushes with gold synthetic bristles. Short acrylic handle with blue tip. Soft Grip™ rubber grip. Shiny silver aluminium ferrule.

PROD.	☐	↔		CODE
711-½"	13	25	4⁷⁵	1420520
711-¾"	19	30	4⁷⁵	1420538

B Soft Grip Brushes™ – Series 250

Round brushes with gold synthetic bristles. Short acrylic handle with blue tip. Soft Grip™ rubber grip. Shiny silver aluminium ferrule.

PROD.	⊙	↔		CODE
250-0	1	9	4⁷⁵	1421726
250-02	2	11	4⁷⁵	1421734
250-04	3	13	4⁷⁵	1421742
250-06	4	19	4⁷⁵	1421767
250-08	5	21	4⁷⁵	1421775
250-10	6	26	4⁷⁵	1421783

C Soft Grip Brushes™ – Series 150

Flat brushes with gold synthetic bristles. Short acrylic handle with blue tip. Soft Grip™ rubber grip. Shiny silver aluminium ferrule.

PROD.	☐	↔		CODE
150-02	3	7	4⁷⁵	1422427
150-04	4	9	4⁷⁵	1422435
150-06	5	10	4⁷⁵	1422443
150-08	6	12	4⁷⁵	1422450
150-10	7	13	4⁷⁵	1422468
150-12	10	15	4⁷⁵	1422476

D Soft Grip Brushes™ – Series 4590

Flat brushes with white synthetic bristles. Long acrylic handle with yellow tip. Soft Grip™ rubber grip. Shiny silver aluminium ferrule.

PROD.	☐	↔		CODE
4590-02	7	15	5⁹⁰	1422179
4590-04	9	18	5⁹⁰	1422187
4590-06	10	21	5⁹⁰	1422195
4590-08	14	25	5⁹⁰	1422203
4590-10	19	29	5⁹⁰	1422211
4590-12	22	31	5⁹⁰	1422229

E Soft Grip Brushes™ – Series 4500

Round brushes with white synthetic bristles. Long acrylic handle with yellow tip. Soft Grip™ rubber grip. Shiny silver aluminium ferrule.

PROD.	⊙	↔		CODE
4500-02	4	10	5⁹⁰	1421437
4500-04	5	21	5⁹⁰	1421551
4500-06	7	28	5⁹⁰	1421577
4500-08	12	34	5⁹⁰	1421635

F Soft Grip Brushes™ – Series 4530

Fan brushes with white synthetic bristles. Long acrylic handle with yellow tip. Soft Grip™ rubber grip. Shiny silver aluminium ferrule.

PROD.	☐	↔		CODE
4530-04	45	22	5⁹⁰	1421676
4530-06	55	25	5⁹⁰	1421684

⊙ Ferrule diameter (mm)

☐ Ferrule width (mm)

↔ Length of bristles (mm)



A Assorted Shapes Small Brushes Set

Set of 6 lovely small brushes with various coloured nylon hairs and assorted colour acrylic handles. Assorted shapes.
7⁹⁵ 1421825

B Paintbrushes with Ergonomic Grip

Paintbrushes with short, ball-shaped handle for easy grasping.
 10 cm **2¹⁰** 1420264
 12 cm **2²⁵** 1420256
 15 cm **2³⁰** 1420249

C Anti-Roll Brushes

24 brushes group set. Natural bristles. Plastic brush with triangular, anti-roll guard.
35⁹⁵ 1420306

D Set of 30 Round Brushes

Set of 30 round, hog bristle brushes, plastic handle and ferrule.
29⁹⁵ 1421791

E Foam Brush

Set of 3 foam brushes (25 mm, 50 mm and 75 mm).
2⁶⁵ 1421395

F Aluminium Brush Washer

With spiral brush stand and filter. ø 10.2 cm.
16⁹⁵ 1201698

Palette Knives

Made of first quality steel. Polished wood handle.
G Curved blade 15 mm x 79 mm **9⁵⁵** 1380237
H Straight blade 15 mm x 80 mm **9⁵⁵** 1380112

I Palette and painting plastic knives

Sets of painting plastic knives used to mix colours or work paste on canvas. Sets of the 5 most popular shapes.
Palette and painting plastic knives
 Bag of 5 knives, 1 of each shape. **6⁷⁰** 1380021
Group Set
 60 knives, 12 of each shape. In a reusable storage box.
67⁹⁵ 1380039

J Plastic Spatula

18 cm **1⁹⁵** 1380765

Painting Accessories

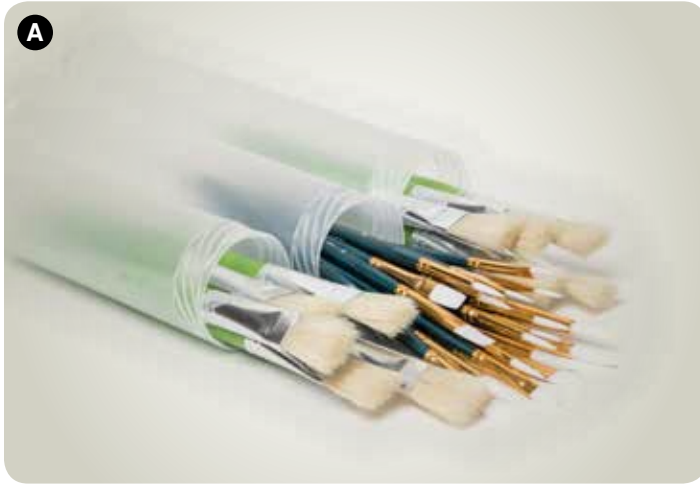

A Paintbrush Plastic Carrying Tube

Brushes sold separately.

4¹⁵ 1209253

B Cotton Paintbrush Bag

Natural cotton bag used to store or carry paintbrushes (not included). 12 slots. 38.5 x 38.5 cm.

9⁸⁰ 1204056

C Manikins

Flexible, sturdy wood manikins with perfect proportions and all-movable joints. 30 cm.

Female **11⁹⁵** 1204106

Male **11⁹⁵** 1201755

D Paintbrush Stand

Made of solid wood and acrylic. Capacity of 24 paintbrushes (not included). 27.5 x 14.5 x 14 cm.

27⁹⁵ 1020247

E Paintbrush Cleaner

Non-toxic, biodegradable and odourless tool and paintbrush cleaner.

473 mL

11⁹⁵ 1201177

1 L

19⁹⁵ 1201193

F Taltine

Odourless solvent for oil paints or cleaning away any solvent-based product.

908 mL

13⁹⁵ 1391739

G Orangel soap 3.6L with pump

Antibacterial hand cleaner white lotion with abrasive pumice, citrus-based solvent that can be used with or without water. It quickly and naturally removes the most stubborn stains such as: rust, grease, paint, tar, urethane, carbon, varnish, spruce gum, mastic, carbon, resin, cement, adhesives, ink. It is also very effective for stains on clothing and leatherette automaker. Its unique formula combines exceptional cleaning power of orange oil with recurring effects of pumice. Comes in a convenient pump. 3.6 L.

19⁹⁵ 1209923



A



B



C



D



E



F



G



H

A Ultra Protection Smocks

Made of thick vinyl for added protection. Clean quickly and easily with a sponge. With front identification pocket.

Age: 4 to 6

Blue	32⁹⁵	2120244
Green	32⁹⁵	2120269

B Smiley Face Smock

Washable nylon apron features sleeves with elastics at the wrists. Pullover style with side Velcro closures. Orange. Size 3-4.

9⁵⁵ 2121796

C Art Smock

Washable nylon apron features sleeves with elastics at the wrists. Easy to put on, slip on the sleeves and join the Velcro pieces in the back.

Red, Size 4 to 6	8³⁵	2121788
Green, size 6 to 8	8³⁵	2123255

D Waterproof Nylon Smocks

Smock made of 100% waterproof and washable nylon. Knitted neckline and cuffs. 2 front pockets. Perfect for arts and craft.

	4 years	Size 6	Size 10
Blue	2037760	2089084	2089092
Pink	2037752	2089068	2089076
	19⁹⁵	19⁹⁵	19⁹⁵

E White Aprons

Plastic. Pack of 100.

57⁹⁵ 1050335

F Plastic Apron

White plastic apron. Pack of 10.

9⁹⁵ 1055938

G Rubberized Mat

Washable, rubberized mat, ideal to protect tabletops and floors. 91 x 152 cm.

10⁹⁵ 2112050

H B&B Black Fabric Apron

Black apron made of 65 % polyester and 35 % cotton. Size: 27.5" wide x 31.5" long. Machine washable and dryer safe.

22⁹⁵ 1204346

Stamps and Stencils

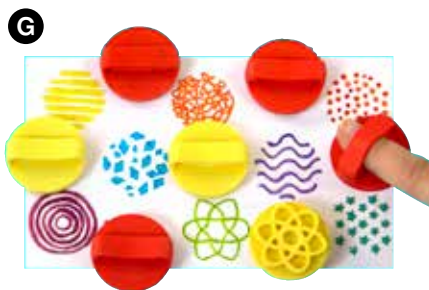

A Stamp Pads

Ink is washable on most fabrics. 10 x 16 cm pads, with flip-lids.

Blue	19⁹⁵	2116655
Green	19⁹⁵	2116622
Red	19⁹⁵	2116697
Yellow	19⁹⁵	2116614

B Giant inkpads

Set of 4 giant-size inkpads, ideal for large foam shapes or stampers (not included). Ink is washable (on most fabrics and surfaces) and dries quickly. With lids. Red, blue, green, yellow. ø 18 cm.

39⁹⁵ 2118362

Creative Rollers

Rollers with embossed patterns to paint or produce patterns in sand. 21 cm long.

C Holidays	25⁹⁵	1203421
4 rolls		
D Fantasy	25⁹⁵	1203439
4 rolls		
E Patterns	14⁹⁵	1209105
5 rolls		

F Fingertip Stamps

Soft plastic, fingertip stamps leave 7 different prints. Set of 24 pieces.

4⁴⁰ 1208065

Rubber Stamps

Set of stamps used to create a variety of patterns.

G Finger	5⁸⁰	1209113
Set of 8. ø 3 cm.		
H Hand	6⁴⁰	1209139
Set of 4. ø 6 cm.		

Rubber Stamps

Sets of 14 giant stampers made of dense foam glued to extra-chunky clear handles. Perfect for use with liquid tempera, felt pens or ink pads.

I Imagination	21⁹⁵	2194348
J Familiar Objects	21⁹⁵	2194355

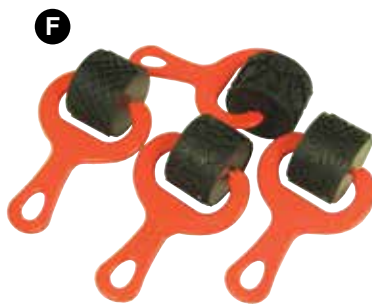

A Small Stencils

Set of 24 stencils on four different themes: Transportation, sea life, insects and animals. 14 x 15 cm.

8⁷⁵ 1211895

B Stencils - People

Set of 12 templates featuring humans in motion. Semi-rigid plastic. Assorted colours. 19 x 23 cm.

6⁴⁰ 1207695

C Stencils - Family Portrait

Set of 9 templates featuring a baby, a boy, a girl, a man, a woman, plus 2 textured, double-sided boards to be rubbed, for fantastic special effects. Semi-rigid plastic. Come with a bilingual teacher booklet. Measure a maximum of 27.5 x 13 cm.

12⁹⁵ 2118453

D Stencils - Feelings

Set of 6 large templates to be used as is, or by taking elements from one or another, to create whimsical faces. Designed to stimulate expressive language and acquire an awareness of self and others. Semi-rigid plastic. Come with a teacher booklet. Measure a maximum of 22 x 20.5 cm.

12⁹⁵ 2118461

Fancy Rollers

Sets of 4 rollers to create texture in modelling clay, Shape it and paint.

E Set No. 1 7⁴⁰ 1209097

F Set No. 2 7⁴⁰ 1209121

Optical Illusion Rubbing Plates

Plates feature raised patterns used for a variety of techniques such as printing, rubbing, moulding, etc.

G Textures Pack of 4 - 8 textures. 28 x 22 cm. 9⁹⁵ 1201615

H Optical illusions Pack of 6. 18 x 18 cm. 9⁹⁵ 1201623

Easels



A Double-Sided Easel for Budding Artists

That double-sided easel has a dry erase white surface on one side and a greenboard on the other. A 4 holes shelf can receive paint containers. Comes with 2 sets of legs: one is 50 cm high and the second is 25 cm, for 115 cm of 90 cm height. Versatile easel for the youngest. Made of pine.

Age: 3 +

59⁹⁵ 1020197

White Paper Roll

White paper roll for easels
46 cm x 23 m. Not shown.

9⁹⁵ 1351956

White Paper Roll

White paper roll for easels
30 cm x 30 m. Not shown.

12⁹⁵ 1351964

B Mobile Easel with 4 Containers

This versatile easel is ideal for "guided reading" books and other group activities.

Features: An enhanced magnetic dry-erase board, a removable/adjustable dry-erase board, an ultra-safe premium book ledge which locks into various positions, (4) 38 x 30 x 15 cm high, open, sliding tubs with stops, to keep activities organized and easily accessible, snap-in chart paper/accessory hooks, and a foot-activated braking system. On 4 large 7.6 cm casters. 78.7 x 71 x 144.7 cm high.

378⁹⁵ 2003788

C Adjustable Double Easel

That sturdy maple wood easel features heavy duty hinges for easy folding and storage after use, 2 clips on each side to hold paper firmly, 2 write and wipe 61 x 61 cm boards and 2 large trays for supplies (not included). Overall height is 122 cm and adjustable.

Age: 4 +

279⁹⁵ 2099513

D See-Through Easel

Clear acrylic easel is ideal to draw or paint portraits, pictures or even words on both sides of the surface. Two children can also work on their respective sides and even mimic each other's gestures, which encourages interaction. Sturdy construction. Floor model with a paint pot holder on each side. On lockable casters. Easy to clean and assemble (no tools required). 50 x 100 cm.

Age: 3 +

172⁹⁵ 2009306

A 



B



C 



A Easel for 4 Children with Storage Cabinet

Multi-purpose, mobile island for 4 children at a time. Features spacious storage areas between the slanted panels and on lower shelves. Removable, tabletop, hard fiberboard easels are securely attached to the base. Includes clips and paint trays (paint not included) on both sides. On casters, for easy mobility. 125.7 x 50.8 x 114.3 cm high.

895⁹⁵ 2003929

B Student A-frame Easel

A-frame easel made of sanded and sealed beech. Height of the chase rack can be adjusted manually. Has an accessory shelf. 162.56 cm high. For max 120 cm high canvas.

63⁹⁵ 1020205

C Double-sided Easel

Double-sided easel features integrated drying rack, internal storage shelf, 2 paint trays, 2 dry-erase panels with built-in clips for paper, and swivel locking casters. Large working surfaces are 60.5 x 68 cm. 70 x 72.5 x 137 cm high.

418⁹⁵ 1020155



About crayons...

Wax crayons

Wax crayons are made from coloured wax, their bright colours are slightly translucent. Wax crayons come in different diameters, once applied, the pigment on the material is rather stable.

Oil pastels

Round stick in bright colours, oil pastels are softer than wax crayons and allow a quick and effective application with very good coverage. Perfect for gradients, colour mixing and carto-engraving techniques.

Dry pastels

Round or square stick that is ideally used on textured materials. Dry, tender and flaky, they are offered in a wide range of colours. If one wants to keep the work, its powdery and fragile nature requires stabilization using an aerosol clear finish.

Colour pencils

Coloured pencil stick covered with a wooden sheath, the coloured pencil is used for drawing in colour and allows to draw with precision and to create fine details.

Markers

The markers consist of an ink reservoir generally contained in a plastic cylinder. There is a wide variety of diameters and tip sizes. The markers are either water-based or indelible ink-based, commonly called permanent marker.





A Prang Wax Crayons

Class pack, in 8 assorted colours.

400 crayons	81⁹⁵	3141017
ø 11 mm		
800 crayons	69⁹⁵	3141009
ø 8 mm		

Crayola Wax Crayons

Group pack featuring wax crayons in 8 assorted colours.

B Jumbo Size

400 big wax crayons, ø 11 mm, (50 crayons of each colour).
69⁹⁵ 3140704

C Regular Size

800 wax crayons, regular, ø 8 mm (100 crayons per colour).
65⁹⁵ 3140670

D Construction Paper Crayons

Class pack featuring 400 wax crayons. 16 assorted colours (25 crayons of each colour).

49⁹⁵ 1171230

E Crayola large crayons and washable markers

Classpack includes a colorful assortment of 128 large crayons and 128 washable markers each in 8 classic colours (16 of each colour).

114⁹⁵ 3140639

Crayons



B



C



D



E



F



G



A Fingertip crayons

Set of 12 easy-grip plastic, conical-shape crayons.

Age: 18 mo + **7²⁰** 1170323

B Plastic Crayons

Plastic crayons offer several advantages: they will not stain, are erasable and can be sharpened like a pencil. Assortments of bright colours. 12 colours.

4³⁵ 1172477

C Colorix Gel Wax Crayons

Wax crayons feature a twist-up tube holder. Brilliant colours with superior hiding power.

6 colours **4⁹⁵** 1170463

12 colours **7⁹⁵** 1172485

24 colours **14⁹⁵** 1172493

D Crayola Washable Wax Crayons

Large, round wax crayons, ø 11 mm. Washable.

8 colours **2⁷⁰** 1171099

16 colours **5¹⁵** 1172048

E Large Crayola Wax Crayons

ø 11 mm. 8 colours.

2⁹⁵ 1170091

F Crayola Anti-Roll Crayons

Triangular, anti-roll crayons. Extra-large (ø 12 mm). 8 colours.

2⁹⁰ 1171933

G Crayola Washable Triangular Wax Crayons

Set of 8 triangular wax crayons. Unique shape allows for more precise and controlled drawing.

3¹⁵ 1170901

**A Prang Wax Crayons** ø 11 mm

8 colours.

2¹⁵ 1171206**B Metallic Fx Crayola Wax Crayons**Truly effective on black or dark paper.
Regular, ø 8 mm. 16 colours.**2⁸⁰** 1172055**C Glitter Crayons**

Set of 16 colours.

2⁴⁵ 1171248**D Crayola Multicultural Wax Crayons**

Regular, ø 8 mm. Set of 8 assorted colours.

0⁹³ 1170778**E Mini Twistables Crayons**

Set of 24 colours. No sharpening needed.

6²⁵ 1171255**F Twistables Crayola Wax Crayons**

Retractable wax stick in a plastic case.

Set of 12 colours.

4⁷⁰ 1172287**G Crayola Wax Crayons**

Regular, ø 8 mm.

8 colours

0⁹¹ 3140019

16 colours

1⁷⁰ 3140035

24 colours

2³⁵ 3140050**H Crayola Wax Crayons**

Boxes of 12 of the same colour.

Regular, ø 8 mm.

Black **1⁵⁵** 3143914Blue **1⁵⁵** 3143922Brown **1⁵⁵** 3143930Green **1⁵⁵** 3143948Orange **1⁵⁵** 3143955Red **1⁵⁵** 3143963Violet **1⁵⁵** 3143971White **1⁵⁵** 3143997Yellow **1⁵⁵** 3143989

Pastels



Diameter ø:
7mm 10 mm 11mm 17mm



A B&B Oil Pastels

High-quality, oil pastel crayons. Soft yet highly durable. Offered at an attractive price.

12 colours

ø 7 mm **2³⁵** 1171214
ø 10 mm **3⁰⁵** 1171149

24 colours

ø 10 mm **6²⁰** 1171156

36 colours

ø 7 mm **5⁹⁵** 1170422

B 12 "Multiethnic" colours

ø 10 mm. **3⁷⁰** 1172089

C B&B Oil Pastels – Solid Colours

Box of 12 sticks of the same colour.
ø 10 mm. Not shown.

Black	3⁷⁰	1170596
Blue	3⁷⁰	1170547
Burnt Sienna	3⁷⁰	1170646
Dark brown	3⁷⁰	1170570
Dark green	3⁷⁰	1170679
Light blue	3⁷⁰	1170562
Ochre yellow	3⁷⁰	1170604
Orange	3⁷⁰	1170612
Pink	3⁷⁰	1170620
Red	3⁷⁰	1170638
Ultramarine blue	3⁷⁰	1170554
Vermillion	3⁷⁰	1170653
Violet	3⁷⁰	1170687
White	3⁷⁰	1170539
Yellow	3⁷⁰	1170588
Yellowish green	3⁷⁰	1170661

D Watersoluble Mungyo Oil Pastels

Boxes of oil pastels in bright and brilliant colours. Water soluble, can be used for watercolour. Very soft, easy to use. Fade-resistant and certified non-toxic.

12 colours **7³⁰** 1172402
24 colours **14⁹⁵** 1172410

E Mungyo Oil Pastels

Assorted round oil pastels in bright and brilliant colors. Made of the finest materials. Suitable for both professionals and students. General grade. Easy to use, these pastels are perfect for all pastel techniques: shading, scratching, mixing colors etc. Fade-resistant and certified non-toxic.

12 colours **3⁹⁵** 1172139
24 colours **6⁹⁵** 1172147
48 colours **10⁹⁵** 1172154
Classpack 12 x 12 Colours **32⁹⁵** 1172170

F Triangular Mungyo Oil Pastels

Assorted oil pastels in bright and brilliant colours. Made of the finest materials. Suitable for both professionals and students. General grade. Easy to use, these pastels are perfect for all oil pastel techniques: shading, scratching, mixing colors etc. Triangular, they are easy to grip and do not roll, perfect for little hands. Fade-resistant and certified non-toxic.

12 colours **3⁹⁵** 1172188
24 colours **6⁹⁵** 1172196

G Gallery Neon Oil Pastels

Neon oil pastel sticks, 70 mm x ø 11 mm.
Box of 12 assorted colours.

4⁹⁰ 1170133



A Mungyo Oil Pastels – Extra large

Oil pastels in vivid colours. 70 mm x ø 17 mm.
 12 colours **5²⁰** 1170166
 24 colours **9⁹⁵** 1170190

Gallery Metallic Oil Pastels

Metallic oil pastel sticks, 70 mm x ø 11 mm.
 Boxes of 12.

- B** Assorted Colours **4⁸⁵** 1170141
- C** Silver **4³⁵** 1170182
- D** Gold **4³⁵** 1170174

E Mungyo Chalk Pastels

Moulded pastels made of the best quality of pigments and plaster. Vivid and brilliant colours. Ideal for childrens practice of drawing. Certified non-toxic. Keep away from moisture.

- 12 colours **4⁸⁵** 1172204
- 24 colours **8⁵⁰** 1172360
- Classpack 12 x 12 colours **44⁹⁵** 1172378

F Gallery Square Drawing Pastels

Square drawing pastels in assorted colours, in a plastic case.
 12 colours **10⁹⁵** 1170109
 24 colours **19⁹⁵** 1170117

G Prang Pastello Square Pastels

Dry, soft pastels.
 12 colours **7⁹⁵** 1171776
 24 colours **8⁵⁰** 1171784

H Gallery Semi-hard Square Pastels

Semi-hard pastel sticks, in luminous colours. Each stick is wrapped and measures 8 x 8 x 82 mm.
 12 colours **10⁹⁵** 1170703
 24 colours **19⁹⁵** 1170737
 36 colours **29⁹⁵** 1170752

I Mungyo Square Soft Pastels

Soft pastel sticks for artists. Each stick is 10 x 10 x 66 mm.
 12 colours **6⁷⁵** 1170257
 24 colours **10⁹⁵** 1170265
 48 colours **18⁹⁵** 1170364

Markers – Class Packs

A



C



D



E



F



A Color'Peps Felt Tips

Sets of sturdy drawing markers. Washable and long lasting ink.

72 markers	33⁹⁵	3293461
144 markers	66⁹⁵	3293487

B Color'Peps Maxi Markers

Those large size markers are perfect for small hands. Wide tapered tip for good covering power. Water washable.

200 Markers	89⁹⁵	3280534
-------------	------------------------	---------

C Prang Classic Markers

Sets of conical point markers in 8 assorted colours.

48 markers	19⁹⁵	1310523
------------	------------------------	---------

D Multicultural Markers

Assortment of ethnic-sensitive colours. Broad line markers have a unique conical tip that is good for coloring and detailing.

	38⁹⁵	1310531
--	------------------------	---------

E Regular Crayola Markers

Box of 256 wide conical tipped markers, which allow to draw fine or wide lines. 16 units of each of the 16 colours. Not washable. Non toxic.

	86⁹⁵	1310895
--	------------------------	---------

F Crayola Washable Markers

Set of 200 conical-tipped washable markers. 25 units in each of the 8 colours.

	99⁹⁵	3144003
--	------------------------	---------



Crayola Washable Markers

Broad line.

A 10 Tropical Colours	4⁹⁵	1311992
B Multi-cultural	4⁶⁰	1313725
8 colours.		
C 10 bright colours	4⁹⁵	1311984
D 10 Classic Colours	4⁹⁵	1311976

E Crayola Washable Markers chisel tip		
8 classic colours.	4⁶⁰	1312859

F Crayola Washable Markers – Scentsations		
10 fruit-scented markers, in vibrant colours. Big, conical points. Washable.	4⁹⁵	1310218

G Crayola Window Markers		
Decorate windows, mirrors, foil paper and more. Washable, non-toxic. Box of 10 markers.	5²⁰	1310200

H Crayola Washable Markers – Colossal Collection		
Washable markers with large, conical tips. 16 l colours.	8³⁰	1310119

I Crayola Washable Markers – Super Tips		
20 colours	6⁴⁰	1310549
50 colours	10⁹⁵	1310556

J Crayola Washable Markers – Fine Tips		
12 markers		
Classic Colours	4⁸⁵	1310564
Bold Colours	4⁸⁵	1311554
24 markers		
Colossal Colours	8³⁰	1311562

K Crayola Washable Markers		
Boxes of 12 markers in solid colours. Large, conical tips.		
Black	7⁰⁵	1314244
Blue	7⁰⁵	1314210
Brown	7⁰⁵	1314228
Green	7⁰⁵	1314277
Orange	7⁰⁵	1314251
Red	7⁰⁵	1314269
Violet	7⁰⁵	1314285
Yellow	7⁰⁵	1314236

Markers



A Color'Peps Maxi Markers

Large size markers perfect for small hands. Wide tapered tip for good covering power. Water washable.

8 colours	4⁴⁰	3280401
12 colours	6⁰⁵	3280443

B Prang Fine Tip Markers

8 couleurs	2⁹⁵	1310853
12 colours	3⁵⁵	1310861
24 colours	7⁹⁰	1310879

C Felt Markers Staedtler Noris Club

Felt tip markers. Washable on most fabrics. 1.0 mm tip.

24 couleurs	2⁹⁵	3280633
24 colours	5⁹⁰	3280641

D Staedtler Triplus Color Fibre-tip Markers

Water-based, dry-safe, colouring markers with pressure-resistant tips and ergonomic triangular shape. In a plastic, stand-up, easel-box.

32 colours	49⁹⁵	3190469
------------	------------------------	---------

E Doubled ended fiber-tip markers

Double end fiber tip markers with stable, pressure resistant tips. Washes easily out of most textiles. One tip allows tracing lines of 0.5mm to 0.8 the other lines of 3 mm.

36 colours	14⁹⁵	3190485
72 colours	34⁹⁵	3190501

F Jumbo Water-Based Chisel Point Markers

These chisel point markers are available in sets of 8 assorted colours, or sold individually.

8 assorted colours	7⁷⁰	1313212
Black	1³⁵	1313253
Blue	1³⁵	1313220
Brown	1³⁵	1313238
Green	1³⁵	1313287
Orange	1³⁵	1313261
Purple	1³⁵	1313295
Red	1³⁵	1313279
Yellow	1³⁵	1313246



A Paper Mate Ink Joy Gel Pen

The fluid gel ink dries now three times faster! With a comfortable grip. Box of 12 assorted colours.

19⁹⁵ 3152790

B Staedtler Triplus Fineliner Felt Pens

Felt pen with ø 0.3 mm fine tip, ergonomic triangular shape. In a plastic, stand-up, easel-box. Dry-safe.

Set of 6 Urban colours

10⁹⁵ 3280674

Set of 10 assorted colours.

15⁹⁵ 3290004

Set of 20 assorted colours.

29⁹⁵ 3280666

C Sharpie Art Pens with Hard Case

The bright, intense colours do not go through the paper. The acid-free, quick drying ink is water and discolouration resistant. Set of 8 colours. 0.8 mm fine point.

19⁹⁵ 3153442

Double ended Markers Le Plume II

Blendable colour pens for colouring books, paper and rubber stamps. Double ended with a brush tip for covering small and large areas and a fine tip for detailing. Use the blending marker to blend colours. Acid-free, non-toxic.

D Marqueur mélangeur Archive quality, alcohol based pigment ink. 3¹⁵ 1312172

E Water based ink. 12 assorted colours. 35⁹⁵ 1312156

F Graph'Peps Fineliner

Sets of extra-fine, soft, precise and sturdy metal tip markers. Versatile, can be used for writing and drawing. Easy-hold triangular shape, do not roll. ø 0.4 mm tips.

10 colours

9⁹⁰ 3293644

20 colours

17⁹⁵ 3293719

G Pilot Frixion™ Erasable Color Markers

Sets of colored markers erasable with 2.5 mm tips. To erase, rub with rubber tip. Leaves no residue and does tear paper. Fast-drying ink. Assorted colors. If ink is exposed to temperatures below -10 ° C or above 60 ° C temperatures, it can delete or return.

6 colours

13⁹⁵ 3292042

12 colours

26⁹⁵ 3292299

H Double-ended watercolour brush markers

Intense dye-based ink. Durable foam brush.

Pack of 18

14⁹⁵ 3190246

Pack of 36

29⁹⁵ 3190279

I Calligraphy marker

Ideal for cards, invitations, awards and certificates. The ink is water-based, acid free, non-toxic. Tip size 2.0 mm / Sepia Colour.

2²⁰ 1312164

J Double-ended Calligraphy Markers

Calligraphy markers with chisel tip.

Box of 12 different colours.

14⁹⁵ 3190238

Markers



A Brush Tip Permanent Marker

Create fine lines, bold strokes and shading. Control the width of your lines with the pressure of your hand. Make your ideas permanent on almost any surface. Brightly colored, fade- and water-resistant ink. Quick-drying ink. AP certified non-toxic formula. 8 assorted colors.

15⁹⁵ 3293362

B Sharpie Permanent Markers

Quick-drying, permanent ink for all surfaces. Resistant and long-lasting tip. Price per unit, sold in 12 unit boxes.

Fine tip

Set of 8 colours **10⁹⁵** 3297066
Set of 12 colours **15⁹⁵** 3297132

Surprising Colours Sharpie Markers

The intense, brightly coloured ink will mark most surfaces permanently. Can be used on paper, plastic, wood and leather. AP certified non-toxic formula.

C 5 Neon Colours / Fine Tip

See ultra vivid color in natural light turn fluorescent in black light. Durable, fine tip produces bold, detailed lines. Smear and fade-resistant, permanent on most surfaces. Great for use on paper, plastic, wood and leather. AP Certified non-toxic. 5 colours.

11⁹⁵ 3293453

D 5 Electro Pop colours / Fine Tip
7⁹⁵ 3153483

E 5 Cosmic colours / Fine Tip
7⁹⁵ 3153459

F 12 Cosmic colours / Fine Tip
18⁹⁵ 3153467

12 Cosmic colours / Ultra Fine Tip
18⁹⁵ 3153475

G 5 Colour Burst colours / Fine Tip
7⁹⁵ 3153491

H Sharpie permanent marker Metallic colours

These markers are made with opaque, permanent ink that leaves real metallic sheen on both light and dark surfaces. Always store tip side down.

7⁸⁰ 3152691

I Sharpie Metallic Permanent Markers

Metallic, permanent, quick-drying ink. Provides a vivid shine on both light and dark surfaces. Fine tip. Per unit.

Bronze **2¹⁵** 3291143

Gold **2¹⁵** 3291119

Silver **2¹⁵** 3291135

J Metallic Markers

Permanent markers for drawings and contours. Can be used on acetate, glass, and porous and non-porous surfaces. 3 different tips available.

	0.5 mm	5 mm	18 mm
Gold	3296225	3296217	3297314
Silver	3296233	3296209	3297322
	3⁶⁵	3⁶⁵	9⁰⁵



A Fabric Markers

These permanent markers with special ink can be used on light as well as on dark fabrics. The fine tip is perfect for details. Acid free, non-toxic and odourless. Dry flat. It is recommended to set colours with heat.

6 colours	25⁹⁵	1312099
Blue	4⁶⁵	1312107
Orange	4⁶⁵	1312115
Yellow	4⁶⁵	1312123

B Black Fabric marker Bold Tip

Writes on most fabric surfaces, especially cotton. Water resistant when dry. Pigmented, odourless ink dries instantly. No steaming or ironing needed. Easy to use, no mess, no clean ups. Acid free and non-toxic.

2³⁰	1312149
-----------------------	---------

C Fabric Transfer Pen

Draw, trace and transfer onto light coloured fabric with the Transfer Pen. Use fabric ironing settings to transfer image. Set of 2 pens.

4⁷⁵	1312131
-----------------------	---------

D Fabric Marker

That marker for fabric uses a special ink that takes on virtually all fabrics. Offers good U. V. resistance. Fine tip.

2⁹⁵	3352911
-----------------------	---------

E T-shirt

For children or adults.

Child, one size fits all	8³⁰	1206028
Adult, one size fits all	9³⁵	1206036

F Sharpie Extreme markers

Sharpie Extreme permanent markers are fade resistant. Ideal on most fabric surfaces. 4 colours. Fine Point.

9⁵⁰	1020619
-----------------------	---------

Fabric Markers and Fabric

A



B



C



D



E



F



G



A Pentel Fabric Wax Crayons

Set of 15 colours, for drawing directly on any fabric. Colours are set with a hot iron. Ideal for preschool and lower elementary levels.

4³⁵ 1170935

B Crayola Fabric Markers

Set of 10 fabric markers.

5²⁰ 1170513

Environmentally – Friendly Bags to Decorate

Sets of 6 environmentally-friendly bags to decorate. Cotton bag in natural colour.

C Small

22 x 20 cm **12⁹⁵** 1209212

D Large

37 x 39 cm **15⁹⁵** 1209204

E Paintable Tote

Designed to carry documents. With zipper. Natural canvas tote to be decorated with acrylic or fabric paints. 25 x 38 cm.

8⁷⁵ 1201383

F Environmentally – Friendly Bags to Decorate

Environmentally-friendly bags to decorate. Cotton bag in natural colour, ideal for shopping. 37.5 x 42 x 9 cm.

4⁷⁵ 1202993

G White Pure Cotton

White Pure Cotton 100 x 90 cm piece.

4⁹⁵ 1209584



Hint from B²

Can I use NEOCOLOR® II on the skin?
 NEOCOLOR® II water-soluble wax pastels bear the symbol CE, which means the product complies with the European regulations of the 'Toy Safety' Directive 2009/48/CEE and EN 71 Harmonised Standards. Caran d'Ache does not recommend the use of NEOCOLOR® II on the body. This product has not been manufactured for cosmetic use and has not been dermatologically tested. NEOCOLOR® II pastels are intended for painting on paper or other surfaces (card, stone, glass, etc.).

Look for "Grim'Tout" on www.bb.ca to find products made for that purpose.



A Caran d'Ache Water – soluble Crayons

Sets of water-soluble Neocolor II artist crayons. The reference in terms of water-soluble crayons! In a tin box.
 CE EN71 and ASTM D4236 compliant.
 Techniques: Wet or dry drawing on various materials, watercolour, wash drawing, scraping or for applying to light panels.
 Not recommended for use on skin.

10 colours	26⁹⁵	1211069
15 colours	39⁹⁵	1211325
30 colours	79⁹⁵	1211333

C Mungyo Watercolour Crayons

Water-soluble crayons made with the finest materials available, in palette of brilliant and luminous colours rich in pigment and fully miscible. To achieve this technique, gently brush over the surface of the drawing with a damp brush to dilute and disperse the colour and create a wash. 93 mm x 8 mm

12 colours	9⁷⁵	1170208
24 colours	17⁹⁵	1170216
36 colours	25⁹⁵	1170224

Group Set
 144 crayons and 12 brushes. 12 different colours, 12 crayons of each.
94⁹⁵ 1172519

D Staedler Ergosoft Watercolour Pencils

The vivid colours are easily miscible and can produce a practically unlimited array of colours. Non toxic. Ideal for elementary grades. Hydrosoluble leads with A-B-S protection, vivid colours, non-toxic. In a plastic, stand-up, easel-box. Superior quality.

12 colours	22⁹⁵	3320090
24 colours	43⁹⁵	3320108

E Lyra Watercolour Pencils

The high concentration of pigments enhances the lightfast properties of the colours. The lines and surfaces can be partially or completely blended with a wet brush to create rich nuances. 4 mm lead. In a metal box.

12 colours	24⁹⁵	3140225
24 colours	44⁹⁵	3140233

F Staedler Watercolour Pencils

These quality hydrosoluble colour pencils combine the joys of drawing and painting and offer the versatility of watercolouring, dry colouring, or a combination of both techniques. The vivid colours are easily miscible and can produce a practically unlimited array of colours. Non toxic. Box of 12 colours, ideal for elementary grades.

12 colours	6⁹⁵	1240407
24 colours	10⁹⁵	1240423

G Lyra Watersoluble Graphite Pencil

Hydrosoluble Watercolour pencil with a soft lead (HB). Perfect for washes and watercolour techniques, by using a wet brush on the drawing to create a palette of gradual colours reaching nearly complete transparency.

	2²⁵	1180389
--	-----------------------	---------

Coloured Pencils

A



B



C



D



E



A Crayola Coloured Pencils

Available in different sizes.

12 colours	3⁹⁵	3140597
24 colours	6¹⁵	3140688
48 colours	10⁹⁵	3144441
60 colours	13⁹⁵	3140738

B Twistable Erasable Coloured Pencils

Retractable, erasable coloured pencils in a plastic body.

12 colours	5²⁵	3140159
24 colours	8⁸⁰	3140134

C Group pack of 72 COLOR'PEPS Color Pencils

Container of 72 color pencils. In a 12 bright colors palette. Easy-hold triangular form, do not roll. Easy-sharpening.

	24⁹⁵	3140399
--	------------------------	---------

D PrismaColor Scholar Coloured Pencils

Available in different sizes.

12 colours	9⁹⁵	3141868
24 colours	19⁹⁵	3141876
48 colours	39⁹⁵	3141892
60 colours	41⁹⁵	3141900

E Crayola Coloured Pencils

Group set featuring 240 coloured pencils, 20 each of the 12 assorted colours.

	56⁹⁵	3140712
--	------------------------	---------

F PrismaColor Pencils

Superior quality, 900 range. Sold individually, minimum 12 units.

Black	1⁷⁵	3142205
Canary yellow	1⁷⁵	3142148
Crimson red	1⁷⁵	3142296
Dark brown	1⁷⁵	3142379
Flesh	1⁷⁵	3142007
Gold	1⁷⁵	3142239
Grass green	1⁷⁵	3142452
Indigo blue	1⁷⁵	3141983
Lemon yellow	1⁷⁵	3142056
Light blue	1⁷⁵	3141959
Magenta	1⁷⁵	3142197
Orange	1⁷⁵	3142247
Pink	1⁷⁵	3142270
Scarlet red	1⁷⁵	3142304
Silver	1⁷⁵	3141926
Slate grey	1⁷⁵	3142155
Spring green	1⁷⁵	3142494
Terra cotta	1⁷⁵	3142353
True blue	1⁷⁵	3141975
Ultramarine	1⁷⁵	3141991
Violet	1⁷⁵	3142460
White	1⁷⁵	3141934

F





A Large triangular coloured pencils Prang

Large 5.5 mm lead. Ergonomic, anti-roll triangular shape. 12 assorted colours.

9¹⁵ 3140209

B Prang coloured pencils

Coloured pencils. 3.3 mm lead.

8 colours **2¹⁰** 3140936
 12 colours **3³⁰** 3140944
 24 colours **5⁴⁰** 3140951
 36 colours **9⁷⁵** 3140969

C Prang Ergonomic Coloured Pencils

Set of ergonomic grip, triangular pencils. Non-slip, staggered grooves for the thumb, index and middle fingers, for an optimal, proper grip, even after sharpening. 3.3 mm.

12 Colours **5⁹⁰** 3140274
 24 Colours **11⁹⁵** 3140282

D Prang Coloured Pencils

Class pack of 288 pencils, 24 each of the 12 assorted colours. In a cardboard box with separators.

66⁹⁵ 3140977

E Lyra Ergonomic Grip Coloured Pencils Class Pack

Class set of 144 ergonomic grip triangular pencils (12 pencils each of the 12 assorted colours). Non-slip staggered grooves for the thumb, index and middle fingers for an optimal proper grip even after sharpening. Ultra-sturdy 3.3 mm lead. In a wooden box.

55⁹⁵ 3140308

F Lyra Skin Tone Pencils

Set of 12 pencils featuring a realistic range of ethnic-sensitive, skin colours.

18⁹⁵ 3140332

G Staedtler Triangular Coloured Pencils

3 mm diameter lead, triangular coloured pencils.

12 colours **3⁷⁵** 3140464

24 colours **7⁴⁰** 3140472

48 colours **14⁹⁵** 1240795

120 colours
 Triangular colour pencils – 120 pencils. **59⁹⁵** 3190295

H Lyra Rembrandt Splendor Colorless Blender

Cover and move colours around to fill in and polish drawings with this colorless blender. Gives a dense, slightly glossy surface. Enhances the intensity of colour pigments, for highly-realistic drawings.

1⁸⁰ 1180223

Chalk, Pastels and Charcoal



Gallery Semi-Hard Pastels

12 pastel in various tones.

A Earth Tones	10⁹⁵	1170448
B Various shades of grey	10⁹⁵	1170497

C Conté Square Crayons

Square-edge, drawing crayons of exceptionally high quality.

6 x 6 x 65 mm. Box of 12 crayons.

2B Black	28⁹⁵	1180926
2B White	28⁹⁵	1180884
Assorted colours	28⁹⁵	1180934
Sanguine	28⁹⁵	1180801

D Gallery Drawing Square Pastels

3 colours available. Box of 6 units.

Black	5²⁰	1171073
Sanguine	5²⁰	1171057
White	5²⁰	1171081

Soft Pastels

Box of 12.

E Cardboard box	7⁷⁵	1181593
F Plastic case	8²⁰	1182591

G Prismacolor Square Pastels

Dry, firm, sturdy, square pastel sticks. Feature luminous, velvety colours.

12 colours	18⁹⁵	1170273
24 colours	38⁹⁵	1170281
White	18⁹⁵	1170299

A **B&B**



B



C



D



E



F



A B&B Charcoals

Box of 10 **2⁹⁵** 1182112
 Box of 50 **10⁹⁵** 1182138

B Stumps

ø 6 x 70 mm. Pack of 12. **4²⁵** 1182427

C Stumps

Made of ultra-soft, grey paper. **1¹⁰** 1182401
 6 mm x 120 mm **1⁹⁵** 1182419
 12 mm x 147 mm

D Lumograph Staedtler Drawing Pencils

Metal box with 6 drawing pencils. HB, 2B, 4B, 6B, 7B, 8B. **11⁹⁵** 1180017

E Lyra Graphite Pencils

Set of 12 pencils offering a wide range of degrees from 6B to 4H. In a metal box. **23⁹⁵** 1180215

F Lyra Drawing Pencils

Set of 12 pencils. Offers a range of shades from warm greys to cold greys including 1 white and 1 black pencil. In a metal box. **22⁹⁵** 1180231

Sketching Pencils

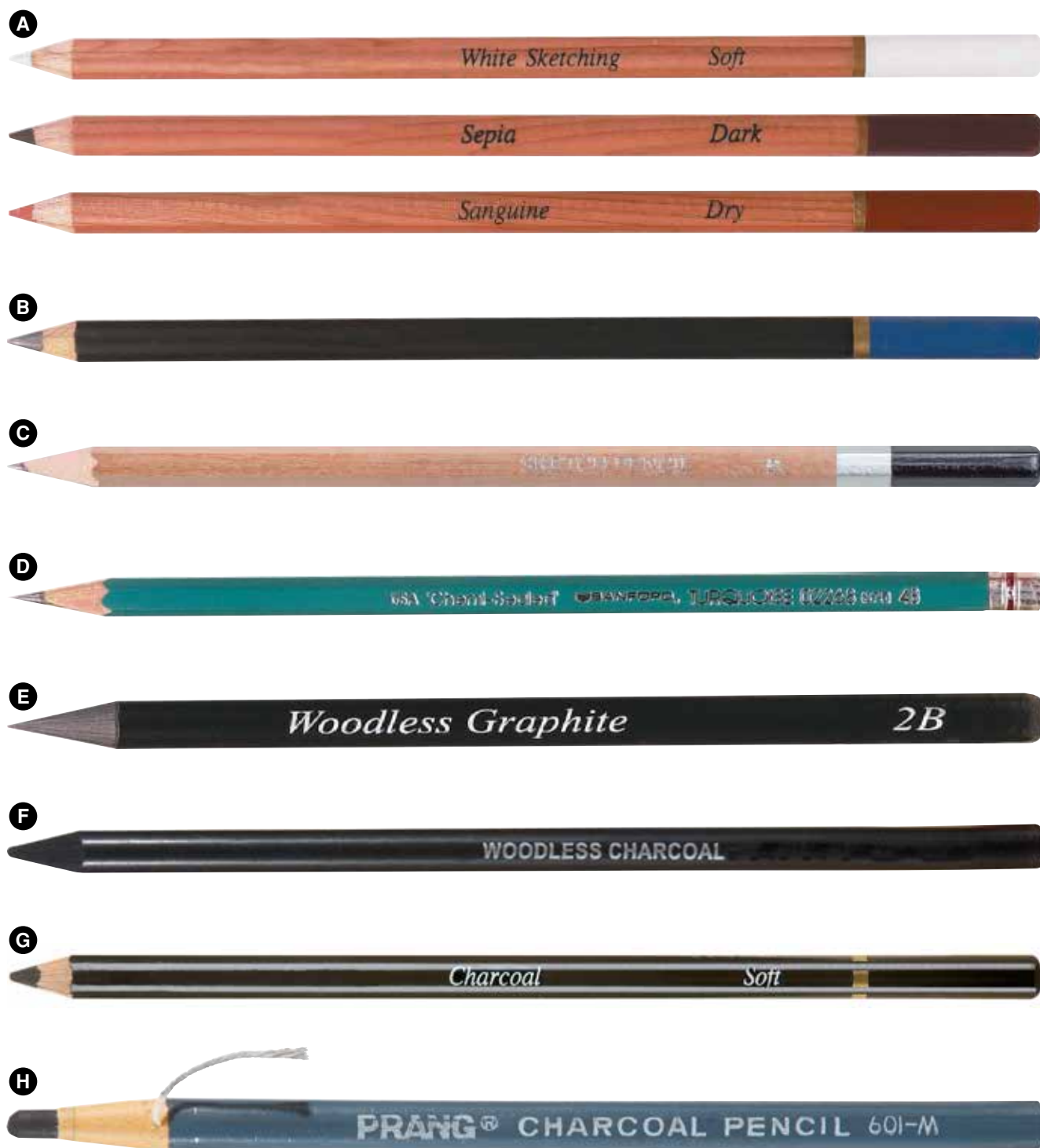

A Drawing Pencils

Available in 3 colours.

Sanguine	1⁹⁰	1182633
Sepia	1⁹⁰	1182625
White	1⁹⁰	1182617

B Sketching and Drawing Pencils

Box of 4 pencils, 1 of each density.

2H, HB, B et 2B	2⁹⁵	1182674
-----------------	-----------------------	---------

C Sketching Pencils

2H	0⁹³	1181023
HB	0⁹³	1182765
B	0⁹³	1181007
2B	0⁹³	1182815
3B	0⁹³	1182807
4B	0⁹³	1182799
6B	0⁹³	1182773

D Turquoise Sketching pencils

2H	1²⁵	1182492
HB	1²⁵	1182534
2B	1²⁵	1182542
4B	1²⁵	1182567
6B	1²⁵	1182583

E Woodless 2B graphite lead

Woodless 2B graphite lead.

3²⁰	1182658
-----------------------	---------

Charcoal Pencil

Compressed charcoal.

F Woodless

Medium **1⁶⁰** 1180025

G Pencil

Soft **2⁴⁰** 1182609

H Prang Charcoal Pencil

Easy to use. Paper-wrapped.

Soft	0⁵⁵	1181098
Medium	0⁵⁵	1181080



A Krylon Clear Finish
318 g can.
Permanent Satin Finish #1303
For watercolour, pastels, charcoal, ink, etc.
11⁹⁵ 1201334
Matte Workable Finish #1306
Ideal for charcoal, pastels or pencil sketching. The choice of professionals.
11⁹⁵ 1201342
Matte Fixative Finish #1311
For photographs, reproductions, etc.
11⁹⁵ 1201359
Permanent Satin Finish #1301
For general indoor or outdoor use.
11⁹⁵ 1400001

B Sanding Pad
Wood paddle stapled with 12 sheets of sandpaper, to sharpen drawing pencils.
2¹⁰ 1204155

C Staedtler Erasing Shield
Flexible, stainless steel. 9.5 x 6.4 cm.
2²⁵ 3320074

D Staedtler Cleaning Eraser
51 x 25 x 22 mm.
1³⁰ 1180173

E Staedtler Eraser Holder
Eraser holder with a clickable pushing system.
2³⁰ 3180221

Refill Eraser
White PVC-free Staedtler eraser stick. Pack of 2.
0⁹⁷ 3180239

F Charcoal Eraser – Kneadable Eraser
Putty type, for charcoal.
1³⁰ 3175585

G Staedtler Erasers
Plastic, soft, latex-free.
Economical # 526-30
Single unit 0⁹³ 3180171
White eraser, Mars-Plastic # 526-50
Single Unit 1²⁵ 3324019

H Pencil Sharpener
Metal, double-hole model.
0⁹⁵ 1182682

I Pocket-Size Pencil Sharpeners
Metal, pocket model, for standard size pencils. Box of 10.
3⁹⁵ 3020153

J Double-Hole Staedtler Tub Sharpener
Pencil sharpener with shavings receptacle, for standard size and jumbo pencils.
4⁹⁵ 3320009

K Round Staedtler Pencil Sharpener
Plastic pencil sharpener, with shavings receptacle. Single hole.
3⁶⁵ 3327723

L Pencil Sharpener
Pocket model, for standard size and jumbo pencils. With shavings receptacle.
1³⁵ 3020294

M X-Acto School Pro Electric Pencil Sharpener
Heavy-duty, quiet model, especially designed for intensive use. Stops automatically. With 6 various-size openings and a very large shavings receptacle.
68⁹⁵ 3020690



What you need to know about papers and cardboards!

Basic Papers

Newsprint Paper

- Very thin greyish-white paper.
- Economical scrap paper.
- Suitable for drawing, first drafts and sketches, preferably with dry products.
- Can also be used for paper mâché.

Cartridge Paper (50 lbs.; 80 g/m²)

- All-purpose, slightly textured white paper.
- Suitable for dry or wet products.

Manilla Paper

- Yellow, corn-based paper.
- Very porous, rough texture.
- Mostly used with dry products.

Construction Paper

- Slight cardboard texture, 90% recycled paper.
- Rough texture and low lightfastness.
- Used with dry products only.
- Also used with découpage and collage projects.
- Available in assorted or same-colour sheets.

Top-Quality Construction Paper

- Top-quality construction paper with satin finish, made of 60% recycled paper.
- Bright colours with superior lightfastness.
- Ideal for découpage and collage projects.
- Available in assorted or same-colour sheets.

Kraft Paper

- White or brown wrapping paper.
- Used as a support for drawing and painting.
- Sold by roll, in 3 different thicknesses and different widths.

Finger Paint Paper

- White paper with a glossy finish.
- Does not absorb water.
- Used mostly with wet products like finger paint, tempera, felt pens and drawing inks.

Tissue Paper

- Thin and translucent paper.
- Vivid colours, low lightfastness.
- Easy to tear.
- Widely used for collages with polymer.
- Available in assorted or same-colour sheets.

Crêpe Paper

- Textured paper with a rough finish.
- Low lightfastness.
- Used for collages and paper shaping techniques.

Fadeless Paper

- White on one side, colour on the other.
- Vivid and lightfast colours.
- Ideal for découpage and collages, can be used with dry products.
- Available in rolls, assorted colours.

Fadeless Duet Paper

- Two-toned paper, with a different colour on each side.
- Used for paper folding, découpage, shaping and 3-D work exposing both colours.
- Highly lightfast.
- Available in assorted colours only.

Watercolour Paper

- Textured, water-resistant paper, available in various weights from 185 g/m² to 300 g/m², in pads or single sheet packages.

Complementary Papers

Patterned Paper

- Paper with various patterns.
- Ideal for collages, folding and Origami.

Cellophane Paper

- Translucent paper.
- Used for collages and paper shaping techniques.
- Available in several colours.

Metallic Paper

- Metallic colours on white backing.

Stained Glass Paper

- Semi-translucent paper in various colours.

Cardboards

Mayfair type Cardboard

- 2-ply cardboard with a rough texture.
- Used as a support for ink, paint and drawing techniques.
- Also suitable for shaping and assembly.
- Available in assorted colours.

Donvale or Brillicolor Cardboard

- 2-ply cardboard with a rough texture.
- Very vivid colours.
- Used as a support for paint and drawing techniques.
- Also suitable for shaping and assembly.
- Available in small and large sizes in assorted colours.

Bristol cardboard

- Bi-fold cardboard, smooth finish.
- Used for drawing, ink, paint, shaping and assembling.
- Offered in various pastel colours.

Corrugated cardboard

- Cardboard that is corrugated on one side and smooth on the other.
- Used for gluing and sculpting.
- Can be used to create voluminous objects.
- Offered in rolls, in a variety of colours.

Product categories

Dry products

- Lead pencils
- Coloured pencils
- Wax crayons
- Dry pastels
- Oil pastels
- Charcoal
- Plastic crayons

Wet products

- Tempera
- Watercolour
- Finger paint
- Indian ink
- Colour ink
- Felt markers
- Markers
- Acrylic paint

**A Regular Cartridge Paper 80 g/m² (50 lbs)**

White paper for drawing. Pack of 100 sheets.

22.8 x 30.5 cm	2⁵⁵	1352756
30.5 x 45.7 cm	4⁹⁵	1352764
45.7 x 61 cm	9⁹⁵	1352772
61 x 91.5 cm	19⁹⁵	1352780

B Newsprint Paper

For sketching and basic exercises. Pack of 500 sheets.

23 x 30 cm	4¹⁰	1357706
30 x 45 cm	8¹⁰	1357714
45 x 61 cm	14⁹⁵	1357722
61 x 91 cm	29⁹⁵	1357730

C Manilla Paper

Corn-based paper. Fine-grained, cream-coloured paper with a porous texture. For pastels, chalks or watercolours. Pack of 100 sheets.

22.8 x 30.5 cm	2⁰⁰	1358522
30 x 45 cm	4⁰⁰	1358555
45.7 x 61 cm	8⁰⁰	1358548
61 x 91.5 cm	15⁹⁵	1358530

D Cartridge Paper 100 g/m² (60 lbs)

All-purpose white paper. Recommended for drawing, markers, etc. Pack of 100 sheets.

23 x 30 cm	3³⁰	1352970
30 x 45 cm	6⁶⁵	1352988
45 x 61 cm	12⁹⁵	1352996

E B&B Cartridge Paper 120 g/m² (70 lbs)

Thick paper, with a rough texture. Can be used with all products. White, sturdy, superior quality. Pack of 100 sheets.

23 x 30 cm	5³⁰	1352806
30 x 45 cm	9⁹⁵	1352814
45 x 61 cm	21⁹⁵	1352822

F Seamless Paper Rolls

Thick paper, ideal for backdrops and group work. Use with tempera, finger paint, etc. 132 cm x 11 m.

95⁹⁵ 1359652**G Drawing paper roll**

White. 45.7 cm x 60 m

34⁹⁵ 1357425**H Banner Bond Paper Roll**

This all-purpose white bond paper roll is 20 lb. Perfect for murals, arts & crafts, signs, banners and displays. Accepts a wide variety of media including paints and markers. Roll size is 36" x 75' (91 cm x 22.8 m). Acid free. Recyclable.

24⁹⁵ 1351915**I White Paper Roll**

White paper roll for easels

30 cm x 30 m.

12⁹⁵ 1351964

46 cm x 23 m.

9⁹⁵ 1351956**J Grey Bogus Paper**Paper with a colour and texture ideal for mediums such as pencil, pastel and charcoal. Natural grey paper, 110 g/m². Pack of 250 sheets.

30 x 46 cm	36⁹⁵	1351220
46 x 61 cm	78⁹⁵	1351238

K Finger Paint Paper

White, waterproof paper, with a glossy finish. Used mostly for finger painting. Good results with inks and markers. Pack of 100 sheets.

75 g/m² (50 lbs)	6⁶⁰	1362680
28 x 41 cm		

80 g/m² (50 lbs)	12⁹⁵	1362698
41 x 56 cm		

100 g/m² (70 lbs)	9⁷⁵	1360148
32 x 48 cm		

120 g/m² (70 lbs)	18⁹⁵	1360155
48 x 64 cm		

L 100% Recycled Kraft Paper

Multi purpose natural kraft paper. Pack of 50 sheets. 30.5 x 45.7 cm.

7⁸⁵ 1350321

Paper

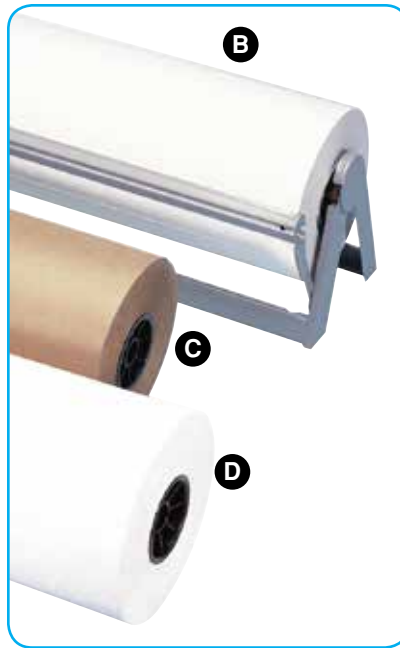

A Paper Roll Dispenser on Wheels

Holds up to 8 rolls of ø 23 cm x 91 cm wide.

1,497⁹⁵ 3281110

B Paper Roll Dispenser

For all standard size paper rolls. Exclusive spring control maintains equal knife-tension for uneven rolls. For rolls of up to 23 cm.

45.7 cm (18 inches)	64⁹⁵	3281136
61 cm (24 inches)	85⁹⁵	3281144
76.2 cm (30 inches)	94⁹⁵	3281151
91.4 cm (36 inches)	95⁹⁵	3281169

C B&B Kraft Brown Paper in Rolls

Base 30

45.7 cm x 366 m (18")	24⁹⁵	3271434
61 cm x 366 m (24")	32⁹⁵	3271442
76.2 cm x 366 m (30")	39⁹⁵	3271459
91.4 cm x 366 m (36")	49⁹⁵	3271467

Base 40

45.7 cm x 274 m (18")	22⁹⁵	3271483
61 cm x 274 m (24")	29⁹⁵	3271491
76.2 cm x 274 m (30")	37⁹⁵	3271509
91.4 cm x 274 m (36")	44⁹⁵	3271517
122 cm x 274 m (48")	59⁹⁵	3271533

Base 60

76.2 cm x 183 m (30")	37⁹⁵	3271558
91.4 cm x 183 m (36")	44⁹⁵	3271566

D Kraft White Paper in Rolls

Base 30

45.7 cm x 366 m (18")	53⁹⁵	1352202
61 cm x 366 m (24")	69⁹⁵	1352210
76.2 cm x 366 m (30")	88⁹⁵	1352228
91.4 cm x 366 m (36")	105⁹⁵	1352236
122 cm x 366 m (48")	144⁹⁵	1352285

Base 40

45.7 cm x 274 m (18")	51⁹⁵	1352244
61 cm x 274 m (24")	68⁹⁵	1352251
76.2 cm x 274 m (30")	85⁹⁵	1352269
91.4 cm x 274 m (36")	102⁹⁵	1352277
122 cm x 274 m (48")	136⁹⁵	1352293

Base 60

76.2 cm x 183 m (30")	85⁹⁵	1352301
91.4 cm x 183 m (36")	102⁹⁵	1352319

E Rice Paper Roll

45.5 cm x 25 m.

32⁹⁵ 1355825

F Rainbow Paper Rolls

Each side features a different surface. The smooth side is ideal for fingerpainting, felt pen, and ink. The rough side is ideal for chalk, tempera, watercolour, acrylic and charcoal. 8 colours.

Black	193⁹⁵	1350073
Blue	193⁹⁵	1350065

Green	193⁹⁵	1350057
Orange	193⁹⁵	1350040
Pink	193⁹⁵	1350081
Red	193⁹⁵	1350024
White	193⁹⁵	1350008
Yellow	193⁹⁵	1350032

G Fadeless Paper in Rolls

	61 cm x 18.3 m	1.22 x 15.2 m
Apple green	1356385	1359264
Black	1356419	1359322
Brown		1359199
Canary	1356369	1359215
Dark yellow		1359348
Emerald green		1359272
Light blue		1359298
Magenta		1359363
Orange		1359231
Pink		1359314
Red	1356351	1359207
Rich blue	1356401	1359306
Sky blue	1356393	1359280
Violet	1356468	1359355
White	1356344	1359181
	29⁹⁵	44⁹⁵



A Construction Paper

Coloured, very economical paper with a slight cardboard texture. Used for collages and drawing. Offered in solid colours. 90% recycled paper. Pack of 50 sheets.

	23 x 30 cm	30 x 45 cm	45 x 61 cm
Black	1353317	1353572	1353838
Blue	1353176	1353432	1353697
Brown	1353218	1353473	1353739
Dark blue	1353184	1353440	1353705
Dark brown	1353226	1353481	1353747
Dark green	1353382	1353648	
Emerald green	1353374	1353630	1353895
Grey	1353267	1353523	1353788
Light blue	1353192	1353457	1353713
Light brown	1353234	1353499	1353754
Lilac	1356617	1356625	1356708
Magenta	1353309	1353564	
Orange	1353325	1353606	1353846
Pink	1353358	1353614	1353879
Scarlet	1353242	1353507	
Violet	1353408	1353663	1353929
White	1353168	1353424	1353689
Yellow	1353275	1353531	1353796
	1⁷⁵	3⁵⁰	7⁴⁰

B Construction Paper

Coloured, very economical paper with a slight cardboard texture. Used for collages and drawing. 90% recycled paper. Assorted colours. 50 sheet packs.

	23 x 30 cm	30 x 45 cm	45 x 61 cm	61 x 91 cm
	1⁷⁵		1353150	
	3⁵⁰		1353416	
	8⁵⁵		1353671	
	17⁹⁵		1353937	

Holiday Construction Paper

50 sheet packs. Not shown.

	23 x 30 cm	30 x 45 cm	45 x 61 cm
Green	1354703	1354695	
Red	1354679	1354661	1360189
	1⁷⁵	3⁵⁰	7⁴⁰

C Poster Paper

Coloured, thin, very economical paper. Used for drawing or folding, shaping and collages. Assorted colours. Pack of 100 sheets.

23 x 30 cm	4¹⁰	1360742
------------	-----------------------	----------------

D Multiethnic Construction Paper

Assortment of ethnic-sensitive colors. Pack of 50 sheets.

23 x 30 cm	4⁴⁰	1355106
30 x 45 cm	8⁷⁰	1355114

E Fluorescent Construction Paper

Packs of 20 sheets.

23 x 30 cm	10⁹⁵	1355122
30 x 45 cm	21⁹⁵	1355130

F Top Quality Construction Paper

Made of 100% sulphite, this tough, satin finish construction paper offers superior resistance and keeps projects brighter and fresher for longer. 60% recycled paper. 50 sheets packs.

	23 x 30 cm	30 x 45 cm
10 assorted colours	1354752	1354927
Black	1354869	1355031
Blue	1354778	1354943
Dark brown	1354794	1354968
Green	1354919	1355080
Lilac	1354836	1355007
Magenta	1354851	1355023
Orange	1354877	1355049
Pink	1354885	1355056
Pumpkin	1354802	1354976
Red	1354901	1355072
Scarlet red	1354810	1354984
Shocking pink	1354893	1355064
Sky blue	1354786	1354950
White	1354760	1354935
Yellow	1354828	1354992
	4⁴⁰	8⁷⁰

Cardboard

A Brillicolor Cardboard (Donvale) Pastel Colours

Donvale type. Pastel colours. Packs of 100. 180 g/m² (120 lbs).

22 x 28 cm

White	3102035	11 ⁹⁵
Sky Blue	3102183	11 ⁹⁵
Lemon	3102175	11 ⁹⁵
Light Grey	3102191	11 ⁹⁵
Pastel Pink	3102167	11 ⁹⁵
Light green	3102209	11 ⁹⁵
Assorted Pastel Colours	3102159	11 ⁹⁵

Brillicolor Cardboard – Pastel Colours

50 x 66 cm

White	3102274	89 ⁹⁵
Sky Blue	3102407	89 ⁹⁵
Lemon	3102399	89 ⁹⁵
Light Grey	3102415	89 ⁹⁵
Pastel Pink	3102381	89 ⁹⁵
Light green	3102423	89 ⁹⁵
Assorted Pastel Colours	3102498	89 ⁹⁵

A



B Brillicolor Cardboard (Donvale) Bright Colours

Donvale type. Bright colours. Packs of 100. 180 g/m² (120 lbs).

22 x 28 cm

Cobalt blue	3102076	11 ⁹⁵
Navy blue	3102142	11 ⁹⁵
Brown	3102068	11 ⁹⁵
Sunshine Yellow	3102118	11 ⁹⁵
Lilac	3102084	11 ⁹⁵
Lime	3102126	11 ⁹⁵
Black	3102043	11 ⁹⁵
Orange	3102100	11 ⁹⁵
Red	3102092	11 ⁹⁵
Emerald Green	3102134	11 ⁹⁵
Assorted Bright Colours	3102001	11 ⁹⁵

Brillicolor Cardboard – Bright Colours

50 x 66 cm

Cobalt Blue	3102308	89 ⁹⁵
Dark blue	3102373	89 ⁹⁵
Brown	3102290	89 ⁹⁵
Sunshine Yellow	3102340	89 ⁹⁵
Lilac	3102316	89 ⁹⁵
Lime Green	3102357	89 ⁹⁵
Black	3102282	89 ⁹⁵
Orange	3102332	89 ⁹⁵
Red	3102324	89 ⁹⁵
Emerald Green	3102365	89 ⁹⁵
Bright Assorted Colours	3102480	89 ⁹⁵

B



C Brillicolor Cardboard (Donvale) Fashion colours

Donvale type. Fashion colours. Packs of 100. 180 g/m² (120 lbs).

22 x 28 cm

Cherry	3102258	11 ⁹⁵
Pink	3102241	11 ⁹⁵
Sun	3102266	11 ⁹⁵
Turquoise	3102233	11 ⁹⁵
Purple	3102225	11 ⁹⁵
Assorted Fashion Colours	3102217	11 ⁹⁵

Brillicolor Cardboard – Fashion colours

50 x 66 cm

Cherry	3102464	89 ⁹⁵
Pink	3102456	89 ⁹⁵
Sun	3102472	89 ⁹⁵
Turquoise	3102449	89 ⁹⁵
Purple	3102431	89 ⁹⁵
Assorted Fashion Colours	3102506	89 ⁹⁵

C





- A Available colours**
- White Yellow Orange Red
 - Blue Black Pink Green



A 2-ply Bristol Cardboard

Packs of 100 sheets. 197 g/m² (133 lbs). 57.1 x 72.4 cm.

Assorted colours	38⁹⁵	3100138
Black	34⁹⁵	3105483
Blue	34⁹⁵	3105426
Canary yellow	34⁹⁵	3105434
Green	34⁹⁵	3105475
Orange	34⁹⁵	3105442
Pink	34⁹⁵	3105467
Red	34⁹⁵	3105491
White	34⁹⁵	3105418

B 2-Ply Fluorescent Cardboard

Pack of 50 sheets, in assorted colours. 197 g/m² (180 m). 55.8 x 71.1 cm.

99⁹⁵	3101243
------------------------	---------

C 4-ply Caribou Cardboard

Packs of 100 sheets. 372 g/m² (250 lbs). 55.9 x 71.1 cm.

Assorted colours	49⁹⁵	3100336
Black	44⁹⁵	3105277
Canary yellow	44⁹⁵	3105251
Dark blue	44⁹⁵	3105210

Emerald green
Light blue
Light green
Magenta
Orange
Red
White

44⁹⁵	3105301
44⁹⁵	3105228
44⁹⁵	3105319
44⁹⁵	3105269
44⁹⁵	3105285
44⁹⁵	3105293
43⁹⁵	3105194

6-ply Caribou Cardboard

Pack of 100 sheet of white 6-ply Caribou cardboard. 55.8 x 71.1 cm. Not shown.

103⁹⁵	3105202
-------------------------	---------

D Illustration Cardboard 50% cotton

Illustration cardboard is hard, made from hot-pressed (soft surface P-27) cold-pressed (rough surface P-79). The applications differ for each surface. Suitable for light wash drawing, acrylic works and even collages.

Smooth (P-27)

38 x 51 (15" x 20"). Pack of 4.	11⁹⁵	1040161
51 x 76 cm (20" x 30"). Pack of 2.	11⁹⁵	1040153

Rough surface (P-79)

38 x 51 (15" x 20"). Pack of 4.	11⁹⁵	1040187
51 x 76 cm (20" x 30"). Pack of 2.	11⁹⁵	1040179

E Poster Board

The combination of clay and finishing paper produces an exceptionally smooth surface. 14 ply. 71 x 111.7 cm (28" x 44").

White	7⁴⁵	1045103
Black	8⁰⁵	1045301

Naturally Grey Cardboard

Thick cardboard, smooth surface. Made of recycled paper. 71 x 111.7 cm. Not shown.

10 ply	4⁰⁵	1040260
20 ply	8⁹⁰	1040278

F Mayfair Type Cardboard

High quality cardboard for all drawing techniques (tempera, ink, charcoal, pastel, etc.). Pack of 100 sheets. 176 g/m² (120 lbs), 50.8 x 66 cm. (20 x 26 in.)

46⁹⁵	3100187
------------------------	---------

Super White Double thickness Cougar Cardboard

Perfect for drawing, printing, painting, this Mayfair type cardboard features a double thickness, a whiteness of 98% and a great opacity. 433 g/m² (160 lbs). Package of 50 sheets of 20 x 26 inches (50.8 cm x 66 cm). Not shown.

67⁹⁵	3100690
------------------------	---------

Decorative Paper



A Cutting or Origami Paper

Assorted colour paper for gluing and cutting.
Pack of 100 sheets. 15 x 15 cm.

7⁶⁰ 1350677

B Origami Paper with Instruction Book

Especially designed for executing the ancient Japanese art of paper folding. Assorted colours.
Pack of 40 sheets. 23 x 23 cm.

19⁹⁵ 1360551

C ARY Cover Paper Assorted Colors

Acid free cover 175 g/m² (65 lb) paper. Perfect for greeting cards, postcard, report covers, rubber stamping, memory books and more. Lignin free, buffered. 50 sheets package. Assortment contains ten solid colors: Violet, Pumpkin, Hyper® Yellow, Rojo Red, Hyper® Lime, Hyper® Pink, Cobalt Blue, Marine Blue, Emerald Green and Gold. Recyclable.

9⁶⁵ 1351923

D Rainbow Paper

Iridescent paper with a smooth, glossy finish.
Pack of 10 assorted sheets. 22.5 x 32 cm.

5⁹⁰ 1350776

Acid-free 90 g/m² (24 lb) Bond paper

Acid-free Bond paper in bright colors that will add a touch of color to your correspondence. Works well in laser and inkjet printers, photocopiers and offset printers. Recyclable.
Pack of 500 sheets. 8½ x 11 in.

E Bright Colours **39⁹⁵** 1351931

F Fashion Colours **39⁹⁵** 1351949

G Mulberry Paper

Coloured paper, translucent and fibrous.
Pack of 10 sheets in different colours. 23 x 31.5 cm.

8⁵⁰ 1350768

H Two-Toned Paper (Fadeless)

Bright colours resist fading. One side is white and the other is coloured. Often used for drawing, folding and sculptures allowing to simultaneously see the white and the coloured sides. Assorted colours. Pack of 60 sheets. 30.5 x 45.7 cm.

16⁹⁵ 1356427

I Two-Toned Paper (Fadeless Duet)

Bright colours resist fading. One side is white and the other is coloured. Often used for drawing, folding and sculptures allowing to simultaneously see the white and the coloured sides. Assorted colours. Pack of 30 sheets. 30.5 x 45.7 cm.

13⁹⁵ 1360858

J Metallic Paper (Fadeless)

Paper with metallic finish, in 6 different colours.
Pack of 24 sheets. 30.5 x 45.7 cm.

12⁹⁵ 1356435



A Diffusion Paper

Allows an easy diffusion of colours to create abstract, multicoloured patterns. Pack of 50 sheets. 30 x 46 cm.

8⁹⁵ 1351055

Diffusion Design Paper

Pre-cut diffusion paper, in assorted shapes.

B Flowers

Pack of 80. ø 23 cm

7⁷⁵ 1350479

C Hands

Pack of 100

14⁹⁵ 1193507

D Butterfly

Pack of 48. 18 x 28 cm

6⁸⁰ 1350487

Origami Paper

15 x 15 cm

E Plain, pack of 300 sheets

9⁹⁵ 1360403

F Patterned, pack of 100 sheets

12⁹⁵ 1360411

G Harmony design paper

Harmony design paper in assorted colours.

Pack of 60 sheets. 12 x 12 cm.

4⁹⁵ 1360437

H Origami paper – Animal Patterns

Animal patterns paper. Pack of 40 sheets. 15 x 15 cm.

4⁹⁵ 1360395

I Duo Origami Paper

100 sheets of double sided colour paper.

15 x 15 cm. In a plastic box.

6⁹⁵ 1360429

Pattern Paper



A Economy Metallic paper

For craft bright projects that shine! This economy metallic paper is the perfect way to illuminate or add sparkling accents to any creation. 64 Sheets printed with 8 different patterns and 8 solid colours, in a variety of colours. 21.5 x 28 cm

19⁹⁵ 1193291

Pattern Papers

Packs of 32 sheets of paper. 22 x 28 cm.

B Hispanic patterns **7⁸⁵** 1350362

C African fabric patterns **7⁸⁵** 1351105

D Stained Glass Paper

Thin, almost translucent paper, printed with beautiful stained-glass patterns. Pack of 24 sheets. 21.4 x 14 cm.

6⁸⁰ 1350370

E Dinosaur Skin

Pack of 40 sheets. 22 x 28 cm.

6⁸⁰ 1350610

F Animal Skin Pattern Paper

Pack of 40 sheets. 21.5 x 28 cm.

7⁸⁵ 1350685

G Frosted Glass

Translucent paper, in assorted colours and patterns. Pack of 24 sheets. 21.4 x 14 cm.

7⁶⁰ 1351089

H Native American First Nations

Paper provides beautiful patterns, in intense colours, developed by some of North America's first people. Many of the designs contain symbols that have a specific meaning to the designer. Includes idea guide. Pack of 32 sheets. 22 x 28 cm.

7⁸⁵ 1351329



A

B



D

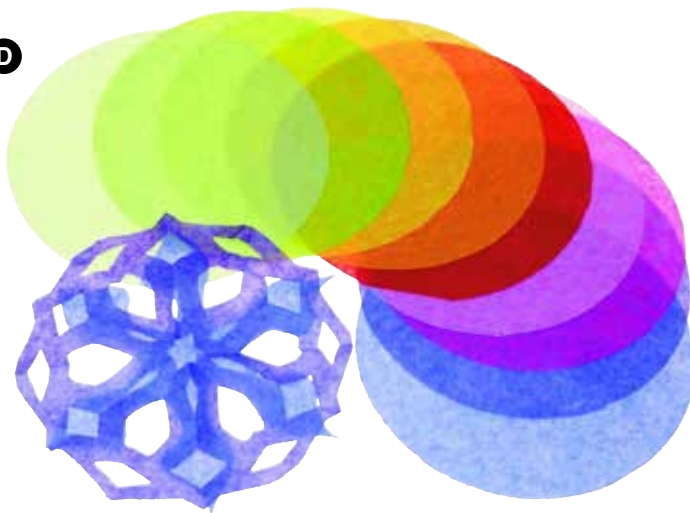

C

A Crepe paper

Flame- and light-resistant. 50 x 200 cm.

Black	1³⁵	1355536
Brown	1³⁵	1355460
Carmine red	1³⁵	1355627
Emerald green	1³⁵	1355486
Flame red	1³⁵	1355635
Green	1³⁵	1355668
Leaf green	1³⁵	1355676
Light blue	1³⁵	1355445
Mint green	1³⁵	1355684
Orange	1³⁵	1355551
Pink	1³⁵	1355619
Primrose	1³⁵	1355585
Purple	1³⁵	1355577
Royal blue	1³⁵	1355452
Shocking pink	1³⁵	1355528
Turquoise	1³⁵	1355643
Violet	1³⁵	1355411
White	1³⁵	1355429
Yellow	1³⁵	1355502

B Narrow Crepe Paper Rolls

Flame-resistant. 4.8 cm x 152 cm.

Baby blue	7⁷⁰	1355874
Black	7⁷⁰	1355924
Green	7⁷⁰	1355973
Orange	7⁷⁰	1355932
Pink	7⁷⁰	1355957
Purple	7⁷⁰	1355940
Red	7⁷⁰	1355965
Royal blue	7⁷⁰	1355882
White	7⁷⁰	1355866
Yellow	7⁷⁰	1355916

C Tissue Paper

Very thin and see-through paper, with bright colours, generally used for its transparency. Packs of 24 sheets. 50 x 76 cm.

American red	3²⁵	1361591
Apple green	3²⁵	1361500
Black	3²⁵	1361450
Brown	3²⁵	1361559
Cherry red	3²⁵	1361609
Chinese red	3²⁵	1361534
Christmas red	3²⁵	1362235

Dark blue	3²⁵	1361641
Dark turquoise	3²⁵	1361625
Dubonnet	3²⁵	1362508
Emerald	3²⁵	1361518
Gold	3²⁵	1361476
Grey	3²⁵	1361674
Lavender	3²⁵	1361583
Light blue	3²⁵	1361617
Light pink	3²⁵	1361567
Light turquoise	3²⁵	1361724
Light yellow	3²⁵	1361468
Medium blue	3²⁵	1361633
Olive green	3²⁵	1361492
Orange	3²⁵	1361526
Plum	3²⁵	1362490
Purple	3²⁵	1361658
Purple pink	3²⁵	1362516
Scarlet	3²⁵	1361542
Shocking pink	3²⁵	1361575
Spring green	3²⁵	1361484
Violet	3²⁵	1361708
White	3²⁵	1361443
Yellow	3²⁵	1361690

Tissue Paper

Very thin, translucent paper, generally used for its transparency.

White

50 x 76 cm / 480 sheets **59⁹⁵** 1361351

20 Assorted colours

30.5 x 45.7 cm / 100 sheets **9⁹⁵** 1362359

38 x 50 cm / 100 sheets **13⁹⁵** 1360122

50 x 76 cm / 100 sheets **18⁹⁵** 1362540

50 x 76 cm / 480 sheets **73⁹⁵** 1362227

Bleeding Tissue Paper

Assorted colours. Pack of 26 sheets. 50 x 70 cm. Not shown. **6²⁵** 1362276

D Tissue Paper Circles

Pack of 480 sheets. ø 10 cm. **7¹⁰** 1351030

Decorative Paper



A Metallic Foil Rolls

Shiny metallic assorted colours, on a white paper back.
65 cm x 7.5 m rolls.

Dark blue	35⁹⁵	1350545
Gold	35⁹⁵	1350560
Green	35⁹⁵	1350669
Light blue	35⁹⁵	1350552
Pink	35⁹⁵	1350578
Purple	35⁹⁵	1350727
Red	35⁹⁵	1350586
Silver	35⁹⁵	1350537

B Fadeless® Metallic Paper Roll

Brilliant sparkling metallic-finish fadeless paper. Adds sparkles when combined to other papers and art materials. Acid free. Recyclable. 60 cm x 2,4 m (24 in. x 8 f.)

Gold	8⁴⁵	1351907
Silver	8⁴⁵	1351899

C Iridescent Cellophane

In a roll. 91.4 x 380 cm.

19⁹⁵ 1209279

D Cellophane Paper

9 colours. In rolls.

	50 x 380 cm	50 x 760 cm
Blue	1357177	1357250
Clear	1356740	1356765
Green	1357235	1357318
Mauve	1357193	1357276
Orange	1357227	1357300
Pink	1357201	1357284
Red	1357219	1357292
Yellow	1357169	1357243

E Metallic Foil Board

Ten sheets of card stock in 5 assorted colours. 21.25 x 27.5 cm.

10⁹⁵ 1352137

F Metallic Foil Paper

Shiny metallic assorted colours, on a white paper back.

21.25 x 25 cm	12⁹⁵	1351733
24 sheets		
50 x 65 cm	43⁹⁵	1351725
20 sheets		

G Stained Glass Paper

10 x 10 cm	8⁵⁰	1350743
500 sheet pack.		
14 x 24 cm	1⁸⁰	1350750
10 sheet pack.		

H Velvet Paper

Rich velvet cotton surface, ideal for oil pastel. Assorted colours. Pack of 20 sheets. 21 x 28 cm.

21⁹⁵ 1363902

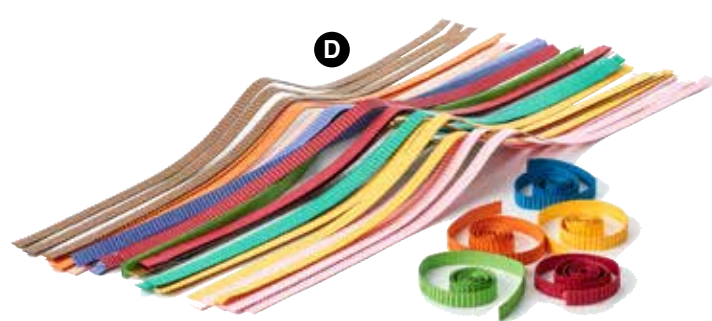

A Smart-fab Disposable Art & Decoration Fabric

With brilliant, never-fading colours and a pleasant texture, this innovative fabric is perfect for decorations and displays, arts and crafts and more. It's fun to work with: flexible yet strong, and easy to cut, staple, fold, glue, sew and paint on. Smart-Fab is disposable and recyclable. It's the smart alternative to paper and cloth. 122 cm x 12.2 m rolls.

45 sheets 22 x 30 cm		
Assorted colours	9⁴⁰	1305523
45 sheets 30 x 45 cm		
Assorted colours	14⁹⁵	1305531
White	25⁹⁵	1305408
Roll 122cm c 12.2m		
Red	25⁹⁵	1305499
Roll 122cm x 12.2m		
Apple green	25⁹⁵	1305515
Black	25⁹⁵	1305457
Dark blue	25⁹⁵	1305424
Yellow	25⁹⁵	1305440
Orange	25⁹⁵	1305465

B Rubber Foam Sheets

Packs of 10 sheet. 23 x 30 cm x 2 mm.

Assorted colours – Plain	5⁵⁰	1205905
Assorted colours – Wavy	5⁹⁵	1121862
Black	4⁹⁰	1205806
Brown	4⁹⁰	1205780
Dark blue	4⁹⁰	1205814
Green	4⁹⁰	1205830
Orange	4⁹⁰	1205863
Pink	4⁹⁰	1205798
Purple	4⁹⁰	1205871
Red	4⁹⁰	1205822
White	4⁹⁰	1205848
Yellow	4⁹⁰	1205855
Assorted colours. 30 x 46 cm.	10⁹⁵	1201961

C Self-adhesive foam sheets

Foam sheets of different colours. 9 x 12 in. (23 x 30 cm).

Plain		
10 colours.	5⁵⁰	1121854
Glitter colours		
6 colours.	5⁹⁵	1090018

D Corrugated paper strips for quilling

Assortment of 13 beautiful colors, including gold and silver. Strips of 1 cm x 50 cm.

	4⁹⁵	1360445
--	-----------------------	---------

E Felt

Top quality felt. **100 x 183 cm. Sold individually.**

Baby blue	9⁹⁵	1301969
Baby pink	9⁹⁵	1302033
Black	9⁹⁵	1302017
Blue	9⁹⁵	1301977
Brown	9⁹⁵	1301985
Dark orange	9⁹⁵	1302025
Medium green	9⁹⁵	1302058
Red	9⁹⁵	1302041
Silver grey	9⁹⁵	1301993
White	9⁹⁵	1301951
Yellow	9⁹⁵	1302009

25 sheet pack. 23 x 30 cm.

Baby blue	8¹⁰	1303239
Baby pink	8¹⁰	1303296
Black	8¹⁰	1303270
Blue	8¹⁰	1303221
Dark orange	8¹⁰	1303288
Light brown	8¹⁰	1303247
Medium green	8¹⁰	1303312
Red	8¹⁰	1303304
Silver grey	8¹⁰	1303254
White	8¹⁰	1303213
Yellow	8¹⁰	1303262

F Coloured Jute

100 x 100 cm.

Natural Jute	3⁸⁵	1302504
--------------	-----------------------	---------

Pack of 100 pieces. 23 x 30 cm.

Assorted colours	31⁹⁵	1302181
50 sheets		
5 of each colour.	24⁹⁵	1121748

Various Materials

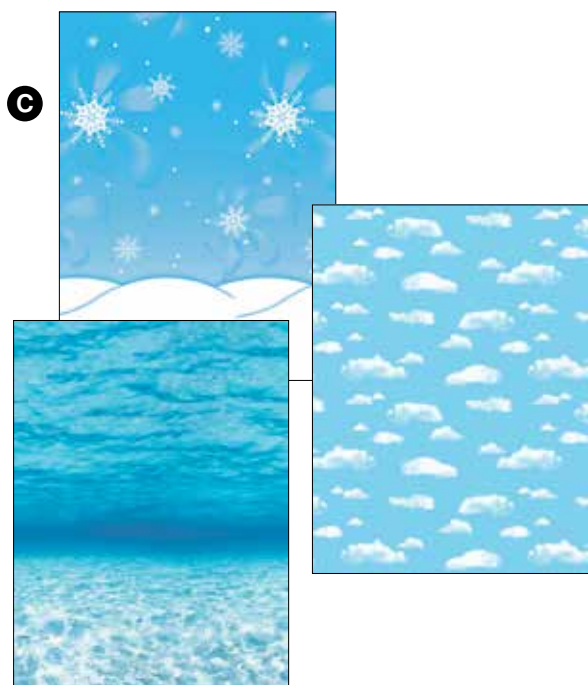

A Bordette in Rolls

Coloured, corrugated paper. One straight edge, one wavy edge. Available in 11 colours. 57 mm x 15 m roll.

Apple green	4⁹⁰	1040047
Black	4⁹⁰	1040088
Canary yellow	4⁹⁰	1040062
Emerald green	4⁹⁰	1040054
Flame red	4⁹⁰	1040104
Orange	4⁹⁰	1040096
Pink	4⁹⁰	1040112
Rich blue	4⁹⁰	1040021
Sky blue	4⁹⁰	1040013
Violet	4⁹⁰	1040070
White	4⁹⁰	1040005

B Metallic Colours Bordette

Coloured, corrugated paper. One straight edge, one wavy edge. 57 mm x 7.5 m rolls.

Blue	11⁹⁵	1040237
Gold	11⁹⁵	1040245
Metallic black	11⁹⁵	1040203
Red	11⁹⁵	1040211
Silver	11⁹⁵	1040252

C Fadeless Design Art Paper

Ideal for murals. 122 cm x 15.2 m roll.

Clouds	44⁹⁵	1350305
Under the sea	44⁹⁵	1350313
Winter	44⁹⁵	1350297

D Coloured Corrugated Paper

Grid print on reverse side, for easier cutting. 122 cm x 7.6 m.

Apple green	32⁹⁵	1044866
Black	32⁹⁵	1044791
Canary yellow	32⁹⁵	1044783
Emerald green	32⁹⁵	1044841
Orange	32⁹⁵	1044809
Red	32⁹⁵	1044833
Rich blue	32⁹⁵	1044734
Royal blue	32⁹⁵	1044742
Sky blue	32⁹⁵	1044718
Violet	32⁹⁵	1044874
White	32⁹⁵	1044700



E Giant Size Corrugated Paper

Brown

91 cm x 15 m	55⁹⁵	1044908
91 cm x 76 m	71⁹⁵	1044890

A **B&B**



B **B&B**



C **B&B**



D



E **B&B**

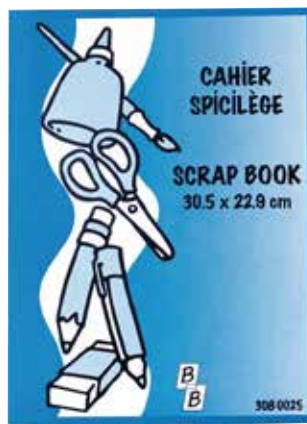

F



G



H



I **B²**



J **B²**



A B&B Sketching Pad

Coil binding, cartridge paper, 30 sheets. 30.5 x 22.8 cm.
1⁹⁰ 3080645

B Sketch Book – Coil Binding

Coil binding, cartridge paper, 24 sheets. 22.8 x 30.5 cm.
3³⁰ 3370368

C International Sketch Pad

Coil binding, cartridge paper 100g/m² / 70 lb. 100 sheets.
 21.5 x 30 cm.
7²⁰ 1500008

D Tracing Paper Pad

44 sheets. 22.8 x 30.5 cm.
7²⁰ 1501675

E Scrapbook – Manilla

20 pages, 30.5 x 22.9 cm.
2⁶⁰ 3080025

F Scrapbook – Newsprint

72 pages, 38 x 28 cm.
2⁵⁰ 3080603

G Studio Sketching Pad

Coil binding, cartridge paper, 30 sheets. 21.5 x 30 cm.
3⁹⁵ 1501659

H Scrapbook

Coil binding, manilla paper, 40 pages, 35.6 x 27.9 cm.
3⁵⁰ 3080611

I Canson Sketch Book

Sketch book 21.6 x 27.9 cm (8.5" x 11"), 100 g/m² (67 lb), acid free.

Perfect Binding

100 sheets. **9⁴⁰** 1351774

Coil binding

80 sheets **9⁴⁰** 1352145

J Universal sketch book

The quality fine-texture paper, offers a versatile surface for a variety of dry media. Erasable and smudge resistant. Wire bound with Micro-Perforated sheets. 96g/m² (65 lb). 100 sheets.

14 x 21 cm (5.5" x 8.5") **6⁸⁵** 1353853

22.8 x 30 cm (9" x 12") **10⁹⁵** 1356153

27.9 x 35.5 cm (11" x 14") **15⁹⁵** 1356161

Sketchbooks and Pads

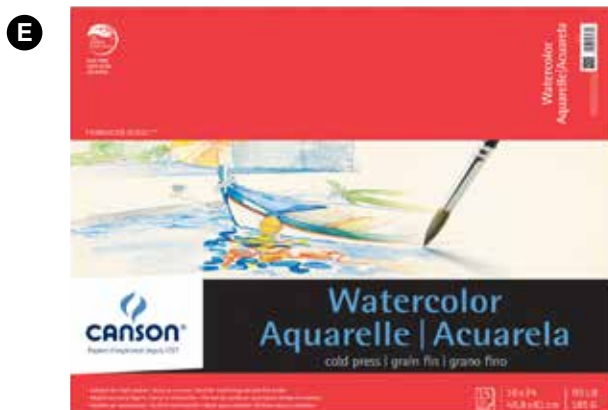

A Palette/Pad

Palette with 40 sheets of waxed paper. Can be used for oils, watercolours and acrylics. 22.8 x 30.5 cm (9" x 12").

7⁹⁵ 1500206

B Canvasette Pad

Ultra resistant, textured paper for acrylic and oil. 10 sheets.

23 x 30 cm (9" x 12") **8⁶⁰** 1500115

30.5 x 40.6 cm (12" x 16") **14⁹⁵** 1500123

C Pastel Pad

Textured paper in assorted colours, ideal for charcoal and pastel. 24 sheet pad. 23 x 30 cm (9" x 12").

9⁹⁵ 1500131

D Watercolour Pad 146 g/m²

Student grade watercolour paper with medium surface texture. Use with watercolour, pencil, ink, tempera and mixed media. Washes do not bleed. Available in pad format perfect for watercolour practice and working outdoors. Acid-free, pH Neutral. 15 easy-to-pull sheets.

22.8 x 30.5 cm (9" x 12") **6⁹⁵** 1359850

28 x 38 cm (11" x 15") **13⁹⁵** 1359868

E Watercolour Pad 185 g/m² (125 lbs)

Economical student grade paper, natural white, free of optical brighteners. High resistance and semi-rough finish, with excellent stability to humidification and pentimento (paper tolerance to correction through application of water). Ideal paper for practicing light washes and combining dry and wet mediums. This pad is handy for working outdoors. Acid-free (neutral pH). 15 easy-pull sheets per pad.

23 x 30 cm (9" x 12") **6⁷⁰** 1500230

38 x 51 cm (15" x 20") **15⁹⁵** 1500255

F Watercolour Pad 300 g/m² (140 lbs)

Natural white paper free of optical brighteners, with semi-rough finish. Cold-pressed for excellent pigment retention and very sturdy paper, with excellent stability to humidification and pentimento (paper tolerance to correction through application of water). The 300 g/m² grade is thick enough to have substance, yet thin enough to withstand various amounts of humidity. It is also the only paper that can be completely immersed in water and retain surface strength, without decomposing. Suitable for watercolour, pencil, ink, tempera and mixed medias. Available in pad form, perfect for watercolour practice and working outdoors. Acid-free (neutral pH). 30 easy-pull sheets per pad.

23 x 30 cm (9" x 12") **8⁷⁰** 1500164

28 x 38 cm (11" x 15") **12⁹⁵** 1500172

30 x 45 cm (12" x 18") **17⁹⁵** 1500180

46 x 61 cm (18" x 24") **32⁹⁵** 1500198

G 100% Cotton Watercolour Support

100% cotton cold press texture paper ideal for watercolour. Developed with artists' partnership, it gives brightness to colours and produces pigment transparency effects. It has the feel and look of handmade paper. Long fibers give enhanced surface cohesion and tearing resistance. Acid and optic azurant free. Anti-mould treated and contains an alkaline buffer. Certified by ISO 9706. 56 x 76 cm (22" x 30")

300 g/m² (140 lbs) **66⁹⁵** 1351782

10 sheets

H Watercolour Paper

Medium surface paper excellent for watercolour, pencil, ink, tempera and mixed media. Washes to not bleed. Acid-free, pH Neutral. Pack of 15 sheets. 56 x 76 cm (22" x 30")

185 g **49⁹⁵** 1359884

300 g **68⁹⁵** 1359892





A Recycled Sketching Pad

Medium grain, good quality paper. Recommended for pencil, pen, ink, etc. 100 sheets. 22.8 x 30.5 cm (9" x 12")

7⁹⁵ 1500149

B XL Mix Media Pad

Perfect for both wet and dry media. Great for experimenting with a variety of mediums – acrylic, watercolor, pen, pencil ink, charcoal, pastel, marker, etc – and techniques. Features consistency, brightness, durability, erasability and smudge-resistance. One side is smooth and the other, vellum. 160 g/m². Acid, lignin and chlorine free.

9" x 12" **12⁹⁵** 1500339

C Tracing Paper Pad

Medium thickness. Pen or pencil tracing paper. 50 sheets.

23 x 30 cm (9" x 12") **6⁷⁵** 1500081

28 x 36 cm (11" x 14") **9¹⁰** 1500099

36 x 43 cm (14" x 17") **12⁹⁵** 1500107

D Vellum Paper Pads

Highly resistant (110 g/m²) tracing paper, with an ultra smooth, satin finish. 50 sheet pad.

22.8 x 30.5 cm (9" x 12") **21⁹⁵** 1500214

27.9 x 35.5 cm (11" x 14") **27⁹⁵** 1500222

E Foundation Bristol Pad

Bright white Bristol offering high contrast. Ideal for pencil, coloured crayons, markers, pen & ink. Excellent for charcoal, watercolours, gouache, airbrush and technical pens. Can also be used for pastel and acrylic. Acid free. 260 g/m². 15 sheets.

9 x 12 smooth **6³⁵** 1500404

9 x 12 vellum **6³⁵** 1500388

11 x 14 smooth **8⁶⁰** 1500412

11 x 14 vellum **8⁶⁰** 1500396

F Tracing Paper Rolls

Exceptionally translucent paper with a smooth surface suitable for pencil, ink, and marker. 25lb (40g). Acid Free.

30 cm x 45.7 m (12 in x 50 yards) **14⁹⁵** 1356179

45.7 cm x 18.2 (18 in x 20 yards) **10⁹⁵** 1356187

60 cm x 18.2 m (24 in x 20 yards) **13⁹⁵** 1356195

Foam Board and Accessories

A White Foam Board

White foam board available in various formats.

50 x 76 cm X 5 mm (min. 10 sheets)	4⁹⁵	1212398
100 x 76 cm X 5 mm (min. 10 sheets)	6⁹⁵	1212372
122 x 244 cm X 5 mm Box of 25	499⁹⁵	1212356

B Coloured Foam Board

Comes in 6 bright colours (1 coloured side, 1 white side). Minimum 10 sheets. 50 x 76 cm x 5 mm.

Black	7⁹⁵	1212463
Blue	7⁹⁵	1212430
Green	7⁹⁵	1212448
Grey	7⁹⁵	1212455
Red	7⁹⁵	1212422
Yellow	7⁹⁵	1212414

Coloured Foam Board

Comes in 6 bright colours (1 coloured side, 1 white side). Minimum 10 sheets. 50 x 76 cm x 5 mm.

Box of 10	69⁹⁵	1212406
-----------	------------------------	---------

Black on Black Foam Board

Black on Black foam board in various formats. Not shown.

100 x 76 cm X 5 mm (min. 10 sheets)	Not shown	8⁹⁵	1212380
122 x 244 cm X 5 mm Box of 25	Not shown	699⁹⁵	1212364

C Foamboard Hole Drill

Drill perfect holes in foamboard. 3 quick-change drill tips included. 3/4", 1/2" and 0.28" diameters. For 3/16" foamboard.

29⁹⁵ 1160829

D Foamboard Straight/Bevel Cutter

Simply rotate the angled base block and Model WC-6010 transforms from a straight cutter to a bevel cutter. Features include adjustable blade depth, ergonomic handle and on-board blade storage. The Straight/Bevel Cutter works with 3/16" foam board. The Straight/Bevel 2 blades included. Use replacement blades 1160811.

18⁹⁵ 1160738

E Foamboard Rabbit Cutter

Create perfect adjoining foamboard joints with FoamWerks Foamboard Rabbit Cutter. The dual blade action creates one-stroke finished results. Ergonomic handle, on-board blade storage. Use as either a right-handed push style or left-handed pull style action. The Rabbit Cutter works with 3/16" foam board. 2 blades included. Use replacement blades 1160811.

18⁹⁵ 1160753

Replacement Blades

20 replacement blades for cutter 1160738 or 1160753.

14⁹⁵ 1160811

F Channel Rail 32"

Aluminum 32 in (81.2 cm). rail. Features channel rail on one side and dual scale on the other. Compatible with Straight Cutter and V-Groove cutter.

29⁹⁵ 1160746

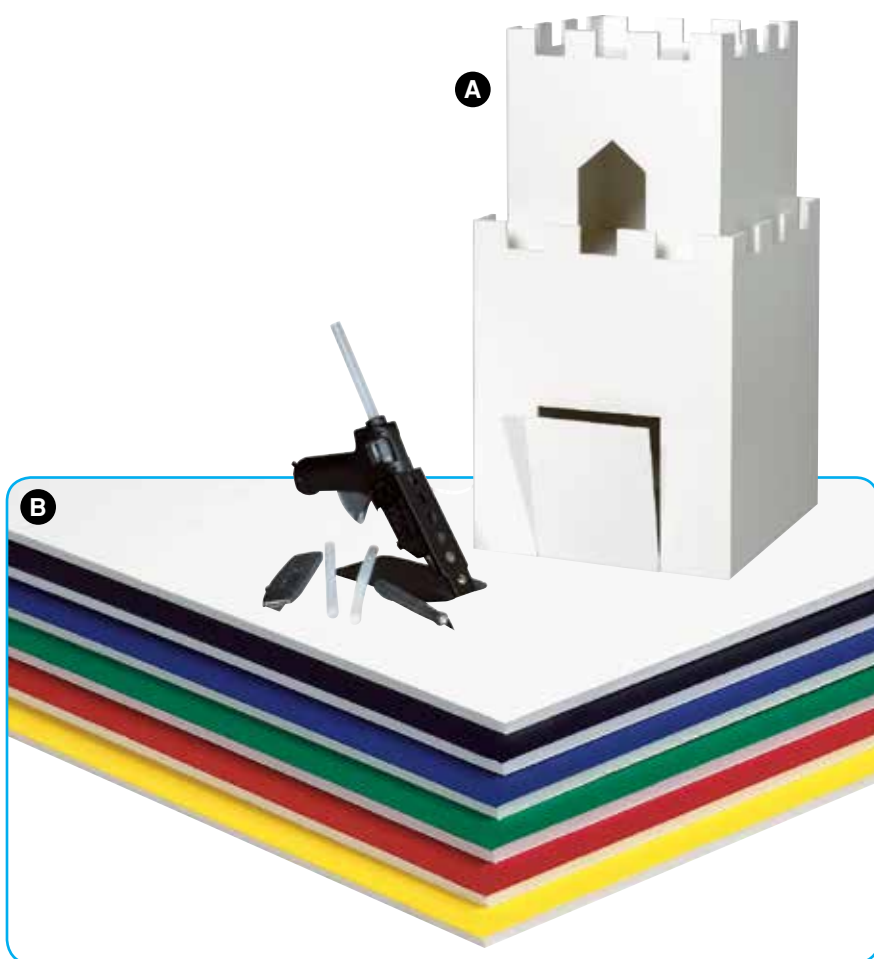

G Foamboard Circle Cutter

Cut perfect circles from 1" to 6" diameters. Center depth indicator shows blade progression for board depths from 1/8" to 1/2". Features dual inch/metric rail, centering pin, magnetic blade slot and clear acrylic safety dome. Five blades. Included.

49⁹⁵ 1160639

Replacement Blades

20 replacement blades for 1160639.

14⁹⁵ 1160795



A Stretched Canvas

Individually wrapped in plastic to prevent soiling. An edge of about 19 mm is bent and fixed to the rear of the subframe to allow one to disassemble and assemble the fabric, while finding the same tension. 4.1 cm stretcher pieces.

Finished cotton canvas.

22.8 x 30.5 cm (9" x 12")	3⁸⁵	1381300
25.4 x 35.5 cm (10" x 14")	4⁴⁰	1381318
30.5 x 40.6 cm (12" x 16")	5⁰⁵	1381334
35.5 x 45.7 cm (14" x 18")	6⁰⁰	1381359
40.6 x 50.8 cm (16" x 20")	6⁹⁵	1381367
45.7 x 61 cm (18" x 24")	8⁷⁵	1381383
50.8 x 61 cm (20" x 24")	9³⁰	1381391
61 x 91.4 cm (24" x 36")	14⁹⁵	1381458

B Canvas Board

Built to our specifications, these quality canvasses are mounted on heavyweight, multi-ply boards. Best used with oil or acrylic paints.

12.7 x 17.7 cm (5" x 7")	0⁶⁸	1380815
15.2 x 20.3 cm (6" x 8")	0⁷¹	1380823
17.7 x 22.8 cm (7" x 9")	1¹⁰	1380831
20.3 x 25.4 cm (8" x 10")	1³⁵	1380849
22.8 x 30.4 cm (9" x 12")	1⁶⁵	1380856
25.4 x 35.5 cm (10" x 14")	2¹⁰	1380872
30.4 x 40.6 cm (12" x 16")	2⁸⁵	1380906
35.5 x 45.7 cm (14" x 18")	3⁶⁵	1380922
40.6 x 50.8 cm (16" x 20")	4⁵⁰	1380948
45.7 x 60.9 cm (18" x 24")	5⁹⁵	1380963

C Canvas Pliers

Chrome steel canvas pliers, with automatic opening. 20 cm.
19⁹⁵ 1340041

D Stretcher Frames

Easy fit, wooden stretcher bars. Sold per unit.

30.5 cm (12")	1²⁵	1380476
40.6 cm (16")	1⁷⁰	1380500
45.7 cm (18")	1⁹⁰	1380518
61 cm (24")	2⁵⁰	1380542
76.2 cm (30")	3¹⁰	1380575
91.4 cm (36")	3⁷⁵	1380609

E White Pure Cotton

White Pure Cotton 100 x 90 cm piece.

4⁹⁵	1209584
-----------------------	---------

F Canvas Roll

Cotton canvas. 152 x 548 cm.

Coated with Gesso (3 coats)	76⁹⁵	1380013
Natural	59⁹⁵	1380005

Scratch Art



A Grafima – Cardboard Engraving Paste BB

This paste has been especially designed for cardboard engraving processes. Adheres well to oil pastels or wax crayons. Can be engraved either in its dry or wet state, and is easily engraved with a sharp instrument. Will not crack. Brushes clean with water.

237 mL **11⁹⁵** 1203660
500 mL **17⁹⁵** 1203652

B Scratch Board

Cardboard covered with black ink to scratch. Pack of 20. 28.5 x 21 cm.

Silver **23⁹⁵** 1040427
Multicolour **23⁹⁵** 1040419

C Basic Tool

Wooden tool is sharp and pointed on one end, and square and flat on the other. 19 cm.

3⁵⁰ 1053073

D Engraving Tools

Professional engraving tool, recommended for scratch-art paper. Plastic handle, metal tip (metal tips sold separately). Packs of 12.

Handles **9⁹⁰** 1201821
Tips **17⁹⁵** 1201839

E Wooden Tool for Engraving

Pack of 25.

3⁵⁰ 1206887

F Rainbow Scratch-Art Paper

Multicolour cardboard covered with white ink to scratch. Pack of 12. 21.6 x 28 cm.

15⁹⁵ 1350511

G Holographic Scratch-Art Paper

Metallic, glitter, multicolour board covered with black ink to scratch. Pack of 10. 21.6 x 28 cm.

15⁹⁵ 1350529

H Scratch-Art Paper

Basic white cardboard covered with black ink to scratch. Pack of 12 sheets. 27.5 x 35 cm.

13⁹⁵ 1350651

I Multicolour Scratch-Art Paper

Engraved lines appear in 6 different colours on each sheet of paper. Pack of 12 sheets. 21.6 x 28 cm.

12⁹⁵ 1351469

J Colour Scratch-Art Paper

This black-coloured cardboard can be scratched or engraved with a sharp instrument. Engraved lines appear in different colours on each sheet of paper. 6 colours. Pack of 12 sheets. 21.6 x 28 cm.

8⁹⁵ 1352053

K Scratch-Lite

Engraved lines or patterns appear in 6 different colours on each sheet, for instant stained glass results. Pack of 10 sheets. 21.6 x 28 cm.

17⁹⁵ 1206622

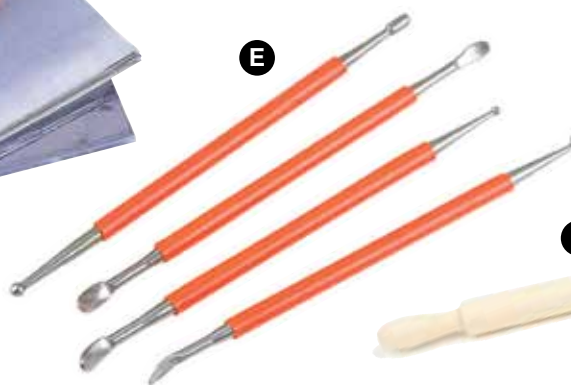
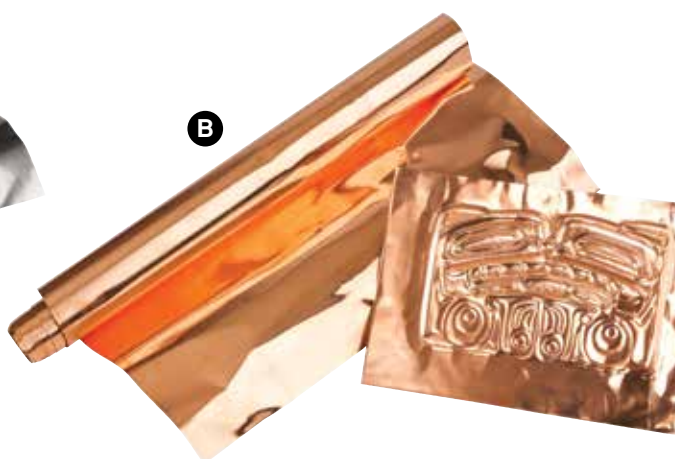

Hint from B²

Process

B & B aluminium is especially suited to cover objects (boxes) or small wooden or cardboard shapes. Before engraving, cover the object with aluminium, inserting a thick layer of newsprint (as a pad) under the surface to be engraved. The newsprint will permanently remain under the aluminium sheet. Engrave with a pointed instrument or a blunt-lead pencil. Once the engraving is completed, cover the surface with a coat of Indian ink.

Before the ink is dry, wipe it off with a cloth, in such a way that it stays only in the grooves.

Indian ink applied to metals gives them the patina of old metal and generally outlines shapes.

Engraved or embossed metals can be painted with stained-glass enamel, if transparent effects are desired, or with ceramic hobby colours, if you want an opaque colour. Metals can also be coloured with permanent markers.

A Embossing Aluminium

Thick durable semi-stiff aluminium. 36 gauge. 30.5 cm wide x 0.13 mm thick.

3 m Roll	12⁹⁵	1200088
113 m Roll	399⁹⁵	1200096
23 x 30.5 cm 35 sheets	31⁹⁵	1200591

B Embossing Copper in Rolls

Proceed exactly in the same manner you would with embossing aluminium. 28 cm wide x 0.13 mm thick.

3 m	49⁹⁵	1190388
-----	------------------------	---------

C Metal Engraving Sheets

19 x 30 cm.

Copper		
3 sheets	5³⁵	1206945
Assorted colours	6⁶⁰	1206952

D B&B Engraving Aluminium

Thin sheet of sturdy aluminium which can be engraved, embossed, shaped or painted. 50 sheets. 24 x 36.5 cm x 0.02 mm thick.

	35⁹⁵	1200104
--	------------------------	---------

E Metal Tools

Set of 4 different tools. The handle and tip are all in one piece and made of high-quality metal. Rubber grip.

13⁹⁵	1340025
------------------------	---------

F Engraving Wooden Tool

Wooden engraving tool. Ideal for aluminium work. 14.6 cm.

5⁷⁵	1201789
-----------------------	---------

Engraving

A

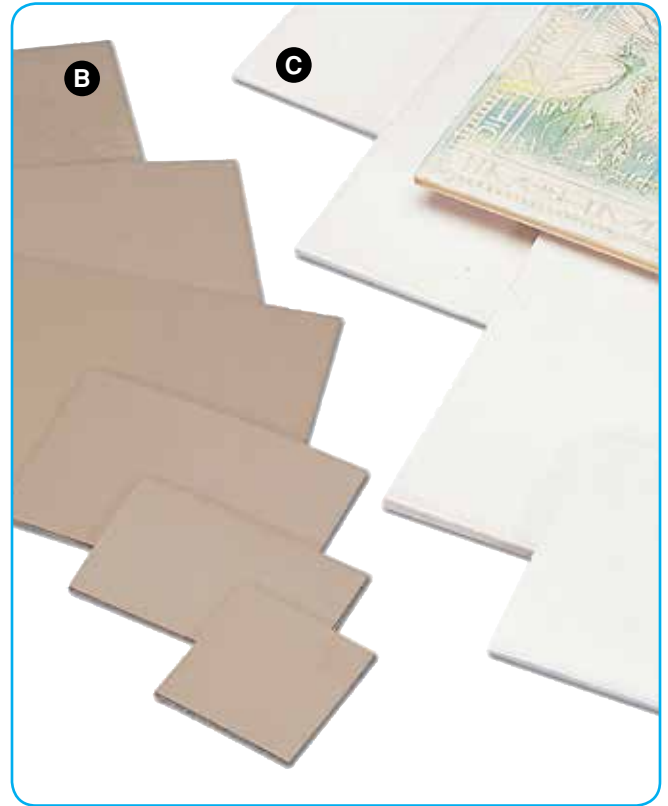
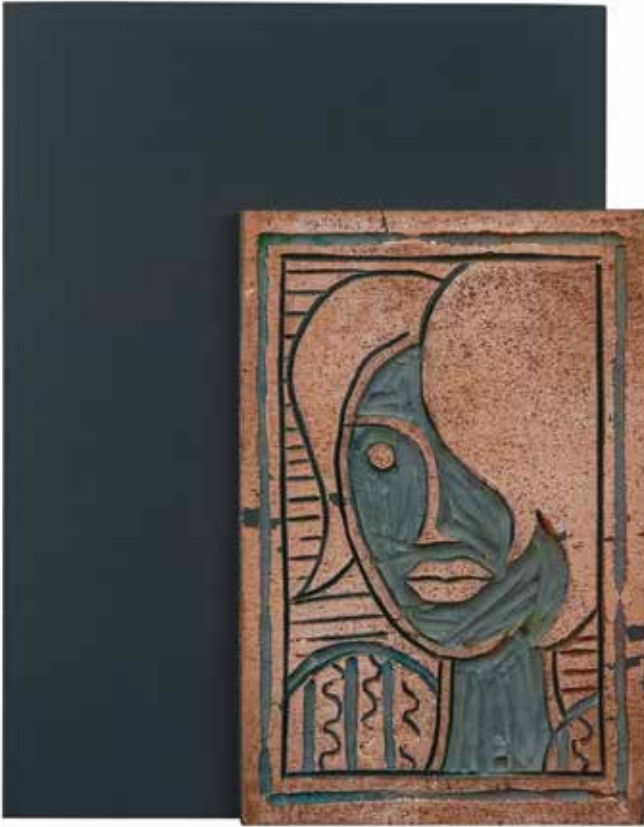

D



A Rubber Tiles

Flexible rubber tiles can be easily carved with chisels. 3 mm thick. Sold per unit.

10.3 x 15 cm	2⁹⁵	1270016
15 x 30.5 cm	7²⁰	1270024
22.8 x 30.5 cm	11⁹⁵	1270032

B Linoleum Tiles

Sold per unit.

7.5 x 12.5 cm	1⁸⁰	1272608
10 x 15 cm	2³⁵	1270867
15 x 20 cm	4⁴⁰	1270875
20 x 25 cm	7³⁵	1272616
23 x 30 cm	9¹⁵	1272632
30 x 30 cm	10⁹⁵	1270883

C Soft Kut Double-Sided Rubber Tiles

This new, flexible, soft material can be easily carved with Oasis or Speedball cutters. This 7 mm tile can be engraved on both sides.

10 x 15 cm	3⁹⁵	1273382
15 x 30.5 cm	10⁹⁵	1273390
23 x 30.5 cm	14⁹⁵	1273408
30.5 x 30.5 cm	18⁹⁵	1273416

D Scratch-Foam Printing Plates

Thin styrofoam sheets. Easy to engrave with a pencil. Cut with scissors. Box of 12 sheets.

8⁸⁰	1203967
-----------------------	---------

**A Speedball Metal Rubber Rollers**

Metal frame, plastic handle. Soft.

# 4172	6 cm	14 ⁹⁵	1273325
# 64-4126	10 cm	17 ⁹⁵	1273366
# 66-4129	15 cm	19 ⁹⁵	1273275

B Speedball Plastic Rubber Rollers

All-plastic. Can be dismantled for easy cleaning. 10 cm.

# 4128	Hard	10 ⁹⁵	1273374
# 4117	Soft	12 ⁹⁵	1273242

C Speedball Lino Cutters

Box of 12.

I straight – 4106	22 ⁹⁵	1160365
O wide – 4105	22 ⁹⁵	1160357
U wide – 4104	22 ⁹⁵	1160340
V narrow – 4101	22 ⁹⁵	1160316
V wide – 4103	22 ⁹⁵	1160332
V medium – 4102	22 ⁹⁵	1160324

D Speedball Lino Handle

Handle only, with adjustable screw. Prod. 4138.

5²⁰ 1161561**E Oasis Lino Handle**

Handle only, with adjustable screw. Prod. LH12.

3²⁰ 1161876**F Oasis Lino Set**

Chisel handle with chisels # L12-1, L12-2, L12-3, L12-4 and L12-5 and . Prod. L5-S

12⁹⁵ 1161884**G Baren Press**

Strong, durable casing. Nylon rubbing surface. Wooden handle. Used for linoleum printing. Prod. 4139.

26⁹⁵ 1270008**H Speedball Lino Set n° 1**

1 adjustable screw handle with chisels # 1, 2, 3, 5, 6. Prod. 4131.

14⁹⁵ 1160373**I Speedball Linozip Set**

1 adjustable handle with Linozip cutters # 6, 21, 22, 23, 25. Prod. 4137.

15⁹⁵ 1160605**K****J Inking Trays**

Sturdy, easy to wash. Pack of 3. 18 x 18 cm.

4⁶⁰ 1141639**K Metal Inking Plate**

Sturdy, metal, inking plate for mixing ink. Prod. 4135

15⁹⁵ 1272871

Printing



A Superior quality Speedball Printing Ink

Water-based ink. Superior quality. 473 mL.

Black	24⁹⁵	1270453
Blue	24⁹⁵	1270479
Brown	24⁹⁵	1270511
Gold	24⁹⁵	1270560
Green	24⁹⁵	1270495
Magenta	24⁹⁵	1270552
Orange	24⁹⁵	1270529
Red	24⁹⁵	1270461
Silver	24⁹⁵	1270578
Turquoise	24⁹⁵	1270545
Violet	24⁹⁵	1270537
White	24⁹⁵	1270487
Yellow	24⁹⁵	1270503

B Speedball Ink Retarder

Retarder for printing inks.

12⁹⁵ 1270230

C Speedball Ink Extender

Ink extender medium, for colour transparency. 147 mL tube.

12⁹⁵ 1270198

D Speedball Printing Ink School Quality

Highly pigmented, true primary colours used to achieve an unlimited chromatic spectre. High viscosity, vibrant, intense colours are compatible with regular Speedball colours.

Water-based, non-toxic inks. 150 mL tubes.

Black	12⁹⁵	1270131
Blue	12⁹⁵	1270156
Red	12⁹⁵	1270149
White	12⁹⁵	1270164
Yellow	12⁹⁵	1270172

E Subi Printing paper

Even-surfaced paper for lino printing, silk screening and printing. Pack of 100 sheets.

11⁹⁵ 1350644

F Speedball manual press

Very sturdy, with adjustable pressing roll. 30 x 60 plate. Prod. 4119.

745⁹⁵ 1272921



A

B



Hint from B²

With a brush, apply the Silk screening drawing liquid on the silk screen. Let dry and block the silk with the Screen-filler obturator. Let the obturator dry and remove the drawing liquid by running the screen under water. You can print on various papers with the Speedball watersoluble screenprint ink, or on fabric with the Speedball fabric ink.



C

D

E

F

G

H

I



J



A Speedball Screenprinting Ink

Watersoluble screenprinting ink, in 237 mL jars.

Black	11⁹⁵	1480474
Blue	11⁹⁵	1480490
Green	11⁹⁵	1480532
Magenta	11⁹⁵	1480516
Orange	11⁹⁵	1480540
Red	11⁹⁵	1480524
White	11⁹⁵	1480508
Yellow	11⁹⁵	1480482

B Speedball Silkscreening Fabric Ink

Water-based ink for printing on all natural and synthetic fabrics. Colours become permanent and machine-washable when set with a hot iron. 237 mL jars.

Black	10⁹⁵	1480672
Blue	10⁹⁵	1480698
Brown	10⁹⁵	1480706
Green	10⁹⁵	1480714
Orange	10⁹⁵	1480730
Red	10⁹⁵	1480680
Violet	10⁹⁵	1480748
White	10⁹⁵	1480805
Yellow	10⁹⁵	1480722

C Silk Screening Frame

Wooden silk screening frame with hinged screen. 25 x 36 cm. **46⁹⁵** 1480037

D Silk Screening – Wooden Frame

Wooden silk screening frame with screen. 25 x 36 cm. **33⁹⁵** 1480029

E Speedball Silk Screen Drawing Liquid

237 mL. **8⁸⁰** 1480854

F Speedball Screen-Filler

237 mL. **12⁹⁵** 1480292

G Silk Screening Mask-Ease

Vinyl film easy to cut with scissors or exacto knife. Draw a pattern on the film and cut the outline of the shape in the vinyl sheet. Apply the clear film to the silk screening wooden frame. The areas exposed and removed from the vinyl film allow the paint to cross through. 50 x 76 cm. **17⁹⁵** 1480862

H Silk Screening Silk

12xx. 107 x 91 cm. **36⁹⁵** 1480359

I Speedball Transparent Extender

Transparent extender for Speedball screenprinting ink. **8⁸⁰** 1480557

J Plastic Squeegee

For printing. **11⁹⁵** 1480326



Everything for modeling, molding, sculpting...

Modeling Clay

Water-based modeling clay (Tutti Frutti)

Very malleable and scented modeling clay, bright colours, always keep in an airtight container, non-toxic and re-hydratable.

Oil-based modeling clay

Vegetable and mineral modeling clays have the advantage of not drying out and being reused time and time again, it is better to keep them in hermetically sealed containers. The colours can be mixed together, ideal for the development of motor skills. Always work on a board or a placemat as it can stain some surfaces.

Ultra-light air-hardening modeling clay

Lightweight and spongy modeling clay that is air-hardening, very flexible and malleable, does not stain and can be painted.

Clay

The red or gray clays require no cooking (with a few exceptions) and are ready to use. They have a natural and moist texture and can be painted once dry. Excellent medium for sensory expression in children.

FIMO modeling clay

Flexible modeling clay ideal for creating small objects such as jewelry. Hardens when baked in a conventional oven.

Hardening powder clay

Composed of a coarse powder, must be mixed with water to become a malleable paste. Can easily be applied on any surface or structure. Can be sanded, painted and varnished.

Direct Sculpting

Sculpting stone (TARASCO)

Synthetic block, wet, easy to carve, dust free.

Soapstone

Soapstone has a high percentage of talc which makes it very malleable to carve. It is also easily carved with sculpting tools for wood. Its colour changes from green to gray.

High density foam carving block

The block of foam can be cut with a saw, dug with a gouge, sculpted with a riffer rasp and sanded with a rasp or a file. You can paint its surface.

To fully appreciate the work of the clay a varied assortment of tools is very important for the little ones, in addition to the tools, a set of cookie cutters is highly recommended



B&B Modeling Clay

Mineral modeling clay that does not dry or harden. Non-toxic. Meets CE and ASTM -D- 4236 standards. Gluten free. Choice of 14 solid colors and 3 sets of 4 colours. 454 g blocks.

A Basic colours

Yellow, blue, green and red. **2⁴⁵** 1373679

B Multiethnic colours

Reproduce a variety of skin tones. **2⁴⁵** 1373836

C Neon colours

Green, yellow, violet and pink. **2⁴⁵** 1373687

D B&B Modeling Clay

Mineral modeling clay that does not dry or harden. Non-toxic. Meets CE and ASTM -D- 4236 standards. Gluten free. Choice of 14 solid colors and 3 sets of 4 colours. 454 g blocks.

Black	2⁴⁵	1373760
Blue	2⁴⁵	1373703
Brown	2⁴⁵	1373711
Dark blue	2⁴⁵	1373828
Green	2⁴⁵	1373802
Grey	2⁴⁵	1373729
Ivory	2⁴⁵	1373737
Light green	2⁴⁵	1373810
Orange	2⁴⁵	1373778
Pink	2⁴⁵	1373786
Red	2⁴⁵	1373794
Violet	2⁴⁵	1373752
White	2⁴⁵	1373695
Yellow	2⁴⁵	1373745

E Tutti Frutti Modeling Clay

Fruit-scented, supple modeling clay in bright colours. Can be rehydrated. Does not stain hands or clothes. Must be stored in an air-tight container after use. Non-toxic.

	250 g	1 kg	
Apple	1371152	1371335	
Banana	1371111	1371293	
Banana (odourless)		1371624	
Blueberry	1371129	1371301	
Blueberry (odourless)		1371632	
Bubble gum	1371145	1371327	
Grape	1371186	1371368	
Orange	1371178	1371350	
Strawberry	1371137	1371319	
Strawberry (odourless)		1371640	
White (odourless)		1371616	
	3⁹⁵	11⁹⁵	

F PATPLUME Vegetable Clay

Vegetal soft and easy to work modeling clay, ideal for very young children. It does not dry out to air and is heat resistant. Non-oily. Perfect for moulds and cutters. Colours can be mixed to infinity. Gluten free. 350 g blocks.

Black	4⁵⁰	1372382
Blue	4⁵⁰	1372366
Brown	4⁵⁰	1372390
Flesh Pink	4⁵⁰	1372440
Green	4⁵⁰	1372374
Grey	4⁵⁰	1372465
Light blue	4⁵⁰	1372457
Light Green	4⁵⁰	1372416
Orange	4⁵⁰	1372432
Pink	4⁵⁰	1372424
Purple	4⁵⁰	1372598
Red	4⁵⁰	1372358
White	4⁵⁰	1372408
Yellow	4⁵⁰	1372341

Modeling Clay and Accessories



A Mad Mattr Crazy Dough

This modeling dough has an ultra smooth texture. Flexible, one can endlessly carve and mould it. No wheat, gluten or casein. Never dries. 280 gr.

Blue	18⁹⁵	1193689
Green	18⁹⁵	1193697
Pink	18⁹⁵	1193663
Purple	18⁹⁵	1193671
Red	18⁹⁵	1193655
Turquoise	18⁹⁵	1193705

B Mad Mattr Tool Box

Set of 20 molding tools of various shapes for Mad Mattr modeling clay with blue and red modeling clay.

44⁹⁵ 1193713

C Mad Mattr Mini Extruder Set

Set of 6 extrusion sleeves of various shapes for Mad Mattr modeling clay. Includes 2 packs of clay: one blue and one red and a knife.

29⁹⁵ 1193721

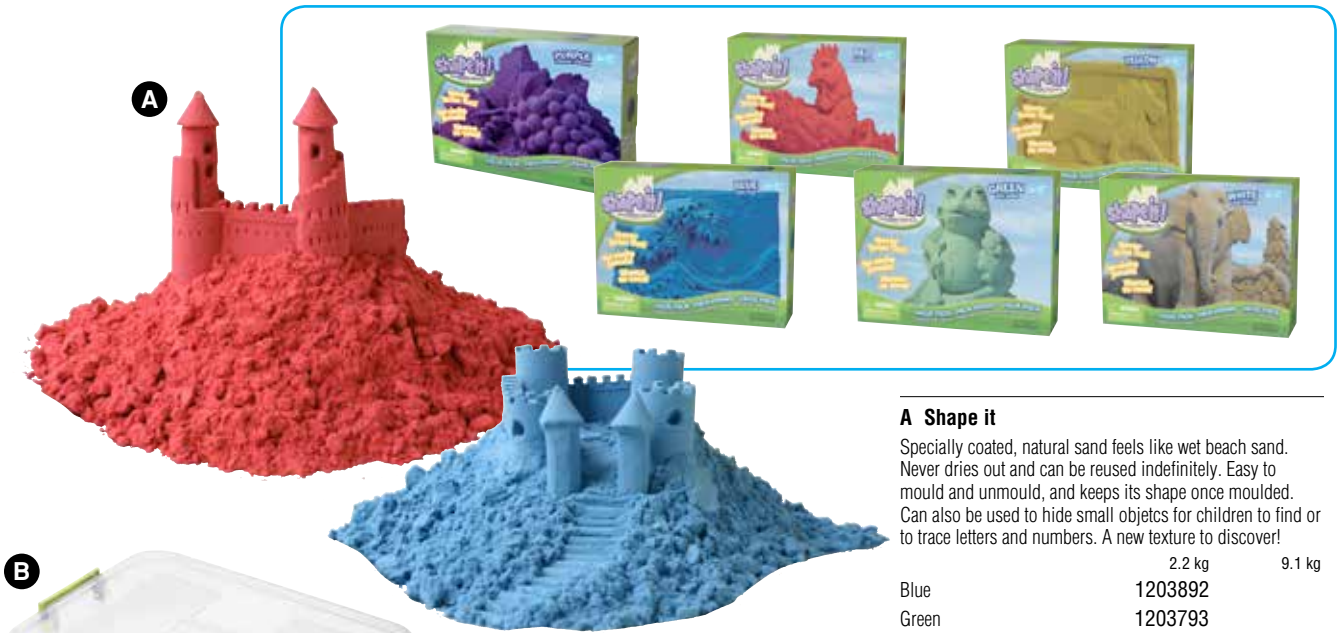

A Shape it

Specially coated, natural sand feels like wet beach sand. Never dries out and can be reused indefinitely. Easy to mould and unmould, and keeps its shape once moulded. Can also be used to hide small objects for children to find or to trace letters and numbers. A new texture to discover!

	2.2 kg	9.1 kg
Blue	1203892	
Green	1203793	
Purple	1193630	
Red	1203868	
White	1203843	1203918
Yellow	1203850	
	34⁹⁵	104⁹⁵

B Individual Tub

Translucent plastic tub with lid measures 38 x 29 x 8 cm. Used to contain sand during moulding play. Ideal for 2.2 kg bag of Moon sand as well as Sands Alive! in 454 g bags. Contrasting, assorted colours handles.

9⁹⁵ 1140078

C Sandcastle Moulds

Set of 8 sturdy plastic moulds to build all the components of a sandcastle.

14⁹⁵ 1204411

D Tabletop Sand and Water Tub

Table model is ideal for small spaces. Sturdy, translucent plastic. Stackable. 70 x 50 x 16 cm high.

46⁹⁵ 2003903

E Play Foam – Group Set

Children simply squish the Play Foam up, shape it in any way they like, squash it back down and start all over again. Light, no-stick formula never dries out and won't stick to carpets or furniture. Non-toxic. Includes (16) 19 x 11.5 x 5 cm super-sized pieces, in 8 great colours.

119⁹⁵ 2207181



Modeling Clay and Accessories



A Model Magic Modeling Clay

Non-toxic, light, soft modeling clay does not stick to the hands. Use a variety of techniques such as making coils, slabs or pinching. Cuts with scissors and air dries in 24 hours. Highly supple and malleable. Colours can be mixed together.

4 neon colours

907 g **22⁹⁵** 1370212

3 earthy colours and 1 White

907 g **22⁹⁵** 1370204

White

75 – 28 g pouches **48⁹⁵** 1370592

113 g **4⁴⁰** 1371087

907 g **22⁹⁵** 1371095

White, blue, yellow and red

907 g **22⁹⁵** 1372671

Blue, red, yellow and white

75 – 28 g pouches **48⁹⁵** 1370600

B Crayola Air Hardening Clay

1.13 kg bucket of air-hardening clay. Made of natural clay, no kiln or oven necessary. Can be sculpted using traditional techniques, and decorated or painted once dry. Cleans easily. White **8¹⁰** 1370733

C Colo-Magic Modeling Clay

Innovative modeling clay with a light texture and soft touch. White, it can be coloured by adding a water-based colour, e.g: washable markers, watercolour, food colouring. Once dry, the different parts of a work can be glued together to assemble the artwork. 140 g. **6⁹⁵** 1172501

D Mungyo Air-Hardening Modelling Clay

Highly supple and malleable, air-hardening, vegetable-based clay. Does not crumble or stain. Can be varnished after drying. Set of 8 assorted colours, in 100 g pots. **15⁹⁵** 1370022

E Mungyo Air-Hardening Modelling Clay

Highly supple and malleable, vegetable-based clay. Air hardens. Does not crumble or stain hands. White.

White **59⁹⁵** 1370030
4.5 kg

A



B



C



A Fimo Soft Modelling Clay

Soft modelling clay. Easily hardens in the oven.
56 g blocks.

Black	2⁸⁰	1370642
Blue	2⁸⁰	1370626
Bright Blue	2⁸⁰	1372267
Caramel	2⁸⁰	1374545
Caucasian Skin	2⁸⁰	1374511
Cherry Red	2⁸⁰	1374479
Chocolate	2⁸⁰	1374552
Cognac	2⁸⁰	1372275
Emerald	2⁸⁰	1374529
Green	2⁸⁰	1370667
Green Apple	2⁸⁰	1371780
Grey	2⁸⁰	1371798
Lavender	2⁸⁰	1372002
Mint	2⁸⁰	1374503
Plum	2⁸⁰	1374537
Purple	2⁸⁰	1371772
Raspberry	2⁸⁰	1374461
Red	2⁸⁰	1370659
Royal Blue	2⁸⁰	1374495
Sahara	2⁸⁰	1371830
Sunflower	2⁸⁰	1371996
Tangerine	2⁸⁰	1371939
White	2⁸⁰	1370618
Yellow	2⁸⁰	1370634

B Set of Fimo Soft Modelling Clay

Supple modelling clay. Easily hardens in the oven.
25 g blocks.

12 colours	15⁹⁵	1372713
------------	------------------------	---------

C Self-Hardening Das Modelling Clay

1 kg		
Terracotta	5⁸⁰	1372333
White	5⁸⁰	1372325

Modeling Clay Accessories



A



B



C

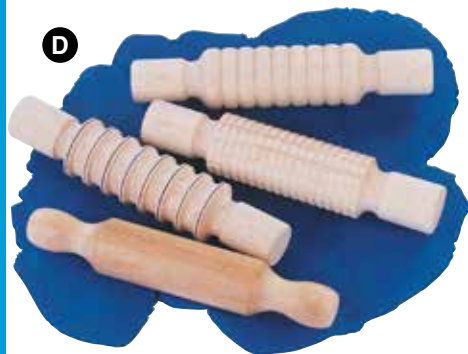

D



E

F



A Wooden Clay Stampers

Set of 4 large stampers for modeling clay each offering a different pattern. A large handle allows child to hold with all the hand. Very resistant. All wood.

17⁹⁵ 2037588

B Cookie Cutters

Set of 25 modelling clay push cookie cutters, to replicate a variety of animal, food and everyday object silhouettes. Approximately 8-10 cm each.

10⁹⁵ 1050038

C Cookie Cutters

Set of 24 modelling clay push cookie cutters, to replicate a variety of animal, food and everyday object silhouettes. Approximately 8-10 cm each.

7⁹⁵ 1050988

D Wooden Rolling Pins

Set of 4 patterned rolling pins, used to create a variety of textures in modelling dough. Sturdy wood. 21 cm.

18⁹⁵ 1208743

E Modelling Tools

Set of 7 tools, in a variety of fun shapes, used to cut, slice or shape modelling clay.

7⁹⁰ 1209220

F Rolling Pin

Plastic rolling pin for modelling clay or to flatten Shape it! 21 cm.

3¹⁵ 1201433

G

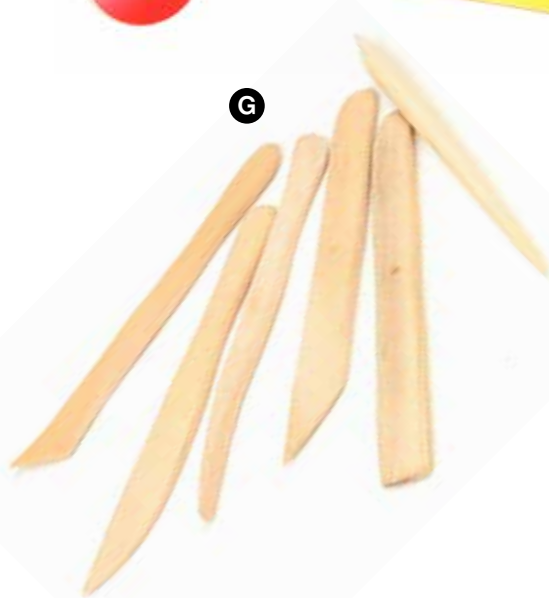

H



G Modelling Tools

Set of 6 tools for pottery and modelling clay.

8⁴⁰ 1053040

H Plastic Place mats

40 x 30 cm, pack of 10.

29⁹⁵ 3090354

I Masonite Base Plates

23 x 30.5 cm **2⁵⁰** 1202381

30.5 x 45.7 cm **2⁹⁵** 1202969

45.7 x 61 cm **4⁴⁰** 1202977

I





A Plaster Strips
Plastered cotton strips in rolls.
1.46 kg
8 rolls **22⁹⁵** 1202357
7.82 kg
32 rolls **67⁹⁵** 1202282

B Fine White Cotton Cheesecloth
91.5 cm wide x 1 m. **3⁴⁵** 1201052

C Plaster of Paris
2.27 kg **6⁹⁵** 1202506
22.7 kg **37⁹⁵** 1202514

D Sculpt'Art Papier-Mâché
Mixes with water to become a malleable paste. Can be applied to all surfaces. Very hard once dry. Can be painted. 500 g.
10⁹⁵ 1358449

E Elmer's Paper Mache Powder Glue
See-through, non-toxic glue will not grow mouldy. A 57 g box yields approximately 3 L of glue. Prepared glue and powder can be kept for a very long time.
5⁹⁵ 1130475

F Sial Alginate
Sial alginate is suitable for making 'temporary' molds of the face, hands and other body parts. Facilitates the reproduction of fine details, gives an accurate reproduction of the original. Crystalline silica free (a known carcinogen) and skin safe.
1.36 kg **55⁹⁵** 1230846
9.07 kg **283⁹⁵** 1230853

G Celluclay Instant Papier-Mâché
Simply add water. Requires no baking. Celluclay is non-toxic and adheres to almost all surfaces. Can be sawed, nailed, sanded or polished.
2.23 kg **59⁹⁵** 1350735
454 g **15⁹⁵** 1358506

H Faces Moulds
Set of 10 face moulds, 2 of each of the 5 different models, measuring approximately 14 x 18 cm each.
13⁹⁵ 1207745

I Stretchable Wireform Mesh
Stretchable and very malleable. Can be modelled on stiff shapes, then covered with papier-mâché, plaster strips or paper dough. 50 cm x 3 m
3 mm mesh **64⁹⁵** 1206804
6 mm mesh **59⁹⁵** 1206788

J Rubber Latex
Moulds created with this white, liquid latex are used to make multiple copies of the original model. Clean tools with water. Non-toxic. Cannot be shipped in freezing weather.
57⁹⁵ 1131648

K Latex
Natural, rubber-based, concentrated formula. Used to mould simple or intricate shapes, low-relief models in a variety of sizes, masks, etc. 250 mL jar.
15⁹⁵ 1234566

Clay



A



B

C

D

E

F

G



A Mexican Pottery Clay

Moist and ready-to-use clay, which hardens without baking. May be used for hand or wheel modelling. Clay objects have a rich colour reminiscent of Mexican or Indian pottery. Once dry, objects are hard and tough, but not waterproof. May later be decorated with watercolours.

2.7 kg **33⁹⁵** 1060144
11. kg **88⁹⁵** 1060151

B Plastisal Clay

Excellent medium to enhance the development of sensory expression in young children. Does not require oven or kiln baking.

1 kg **4³⁰** 1060813
5 kg **15⁹⁵** 1060797
22.7 kg **54⁹⁵** 1060805

C Marblex Clay

Grey clay which requires no baking. Clay objects become very hard, but are not waterproof. 2.27 kg box. Prod. X25

33⁹⁵ 1060532

D Amaco Moist Clay

Ready-to-use clay. Clay objects dry as hard as chalk. Once dry, they can be baked or decorated with opaque, no-bake paints such as DECO decorative paint. 2.2 kg plastic bag. Prod. X11

31⁹⁵ 1060136

E Earthenware n° 10F

Earthenware n° 10F highlights the features of Quebec's most beautiful shale, found in St-Octave-de-Métis. With a colour palette ranging from terracotta to brown, this clay is a craft as well as an industry favourite. Cone 02 to 4. 22.7 kg box.

46⁹⁵ 1060904

F Earthenware n° 25F

Sial 25F clay has been formulated according to the traditions of fine, European earthenware. Its plasticity and wheel-throwing properties make it an exceptional clay. Colour ranging from white to ivory. Box of 22.7 kg.

46⁹⁵ 1060839

G Vallauris Clay

Ready to use and reusable. Does not require oven baking. Suitable for Fine Arts' as well as preschool classes.

1 kg **4³⁵** 1061217
5 kg **15⁹⁵** 1061225
22.7 kg **54⁹⁵** 1061233

**A Pottery Tool Kit**

Set of basic pottery tools consisting of: loop tool, ribbon tool, potter's rib, needle, wooden modelling tool, sponge, scraper, nylon clay cutter.

19⁹⁵ 1053842

B Pottery Tool Kit

Includes 7 wooden modelling tools and 2 hole cutters.

21⁹⁵ 1057652

C Basic Modelling Tools Set

Set of 3 essential tools for clay and modelling clay. Includes 2 modelling tools and 1 hole cutter.

10⁹⁵ 1053495

D Needle

Used to pierce or polish uneven surfaces. Thin and sturdy. A must-have tool for precision work. 14 cm.

3⁹⁵ 1053594

E Pro Tool

Sturdy, sharp needle. 15.5 cm.

5⁹⁵ 1054006

F Clean-Out Tool

16.5 cm.

5⁹⁰ 1053990

G Sgraffito Tool

Tool with sturdy wire loops on each end. 15 cm.

5¹⁰ 1054139

H Cutting Wire

For cutting and slicing clay blocks.

2⁷⁵ 1053867

I Hole Cutters

Wooden-handle wire tools for slicing, cutting and sculpting clay.

15 cm. #8 **4⁵⁰** 1051374

J Aluminium Decorating Wheel

ø 17.8 cm.

48⁹⁵ 1056225

K Rolling Pin

Wood. ø 6 cm x 27.8 cm long.

19⁹⁵ 1050053

L Reinforcing Wire

Highly flexible aluminium wire, used to strengthen sculptures, massive structures or frames.

ø 3.2 mm x 6 10 m **12⁹⁵** 1204254

ø 4.8 mm x 3 05 m **14⁹⁵** 1204262

M Chicken Wire

2.5 x 2.5 cm mesh. 91 cm wide x 15 m long roll.

43⁹⁵ 1206481

Sculpting Blocks and Tools

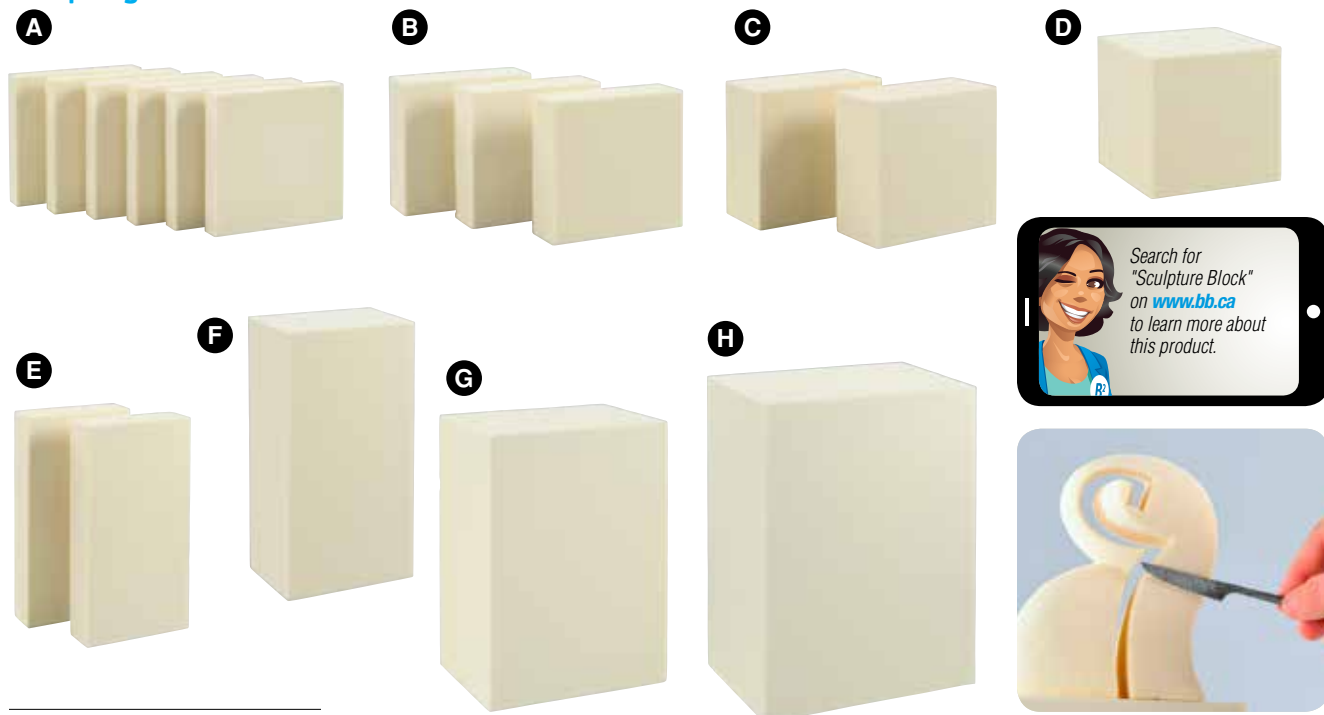

Sculpture Block High Density Foam for Sculpting

Extremely light and strong sculpture material for long-lasting results.

Available in 3 different series with the basic sizes 15 cm, 30 cm, 40 cm, 60 cm and 100 cm height.

Easy to shape, user-friendly and much faster to use than any other sculpture product. You can create highly refined and detailed sculptures.

The material is ready to use and requires no preliminary or follow-up treatment. It is very cost-effective compared to wood or stone. Can be shaped with a saw, a chisel or a file. Can be used for any design of shape. Suitable for young and old, experienced or beginner.

A 15 x 15 x 2.5 cm

6 pieces **19⁹⁵** 1020288

B 15 x 15 x 5 cm

3 pieces **19⁹⁵** 1020296

C 15 x 15 x 7.5 cm

2 pieces **19⁹⁵** 1020304

D 15 x 15 x 15 cm

1 piece **19⁹⁵** 1020312

E 30 x 15 x 5 cm

2 pieces **24⁹⁵** 1020320

F 30 x 15 x 10 cm

1 piece **24⁹⁵** 1020338

G 30 x 20 x 15 cm

1 piece **39⁹⁵** 1020346

H 40 x 30 x 20 cm

1 piece **89⁹⁵** 1020353

Group Sets

I Boards

36 pieces. 15 x 15 x 2.5 cm each. **109⁹⁵** 1020361

J Blocks

54 pieces. 15 x 5 x 5 cm each. **109⁹⁵** 1020379

K Drill rasp tool 36cm

Versatile tool that allows you to drill holes and precisely perforate the Sculpture Block® sculpting blocks. Can also be used as a rasp, file and works well with wood, plaster and clay. Rubber handle.

12⁹⁵ 1020437

L Sculpting set with 15 tools

Sculpting tool set, including 6 wire scrapers of various precision, 1 v-shaped chisel, 1 u-shaped chisel, 5 different files and 2 pieces of sand paper.

32⁹⁵ 1020486



M Carving chisel

Set with 2 carving tools: 1 v-shaped chisel, 1 u-shaped chisel. Rubber handle. 16 cm.

9⁹⁵ 1020445

O Precision Wire scrapers

Set includes 6 precision wire scrapers, ideal for sculpting blocks, clay and modeling clay. All metal. 12.5 cm.

9⁹⁵ 1020460

N Set of 5 rasps

Set includes 5 rasps made of steel with a rubber handle. 18 cm.

12⁹⁵ 1020452





A Sculpting Tools for Soap Stone

Set of 12 sturdy knives for sculpting soap stone. 15 cm. Prod. 300-1.

23⁹⁵ 1162007

B Jingoro Sets

Assortment of knives and a sharpening stone. Can also be used for lino cutting.

Set of 6 **7⁵⁰** 1471085

Set of 12 **13⁹⁵** 1471093

C Knife

Utility knife.

2²⁰ 1160456

D Set of 10 Sculpting Tools

Set of 10 assorted tools. Varnished wood handle. In a wooden case. 15 cm. PM230.

23⁹⁵ 1162015

E Set of 6 Sculpting Tools

Set of 6 assorted knives for sculpting wood. Varnished wood handle. 24 cm.

39⁹⁵ 1162049

F



F Soap Stone

Soap Stone
10 x 10 x 10 cm **27⁹⁵** 1202308
Assorted sizes 45.3 kg **304⁹⁵** 1205285

G



G Tarasco

Synthetic stone, for dustfree sculpting.
10 x 10 x 6 cm **6⁹⁵** 1203694
10 x 10 x 18 cm **12⁹⁵** 1203702

Styrofoam

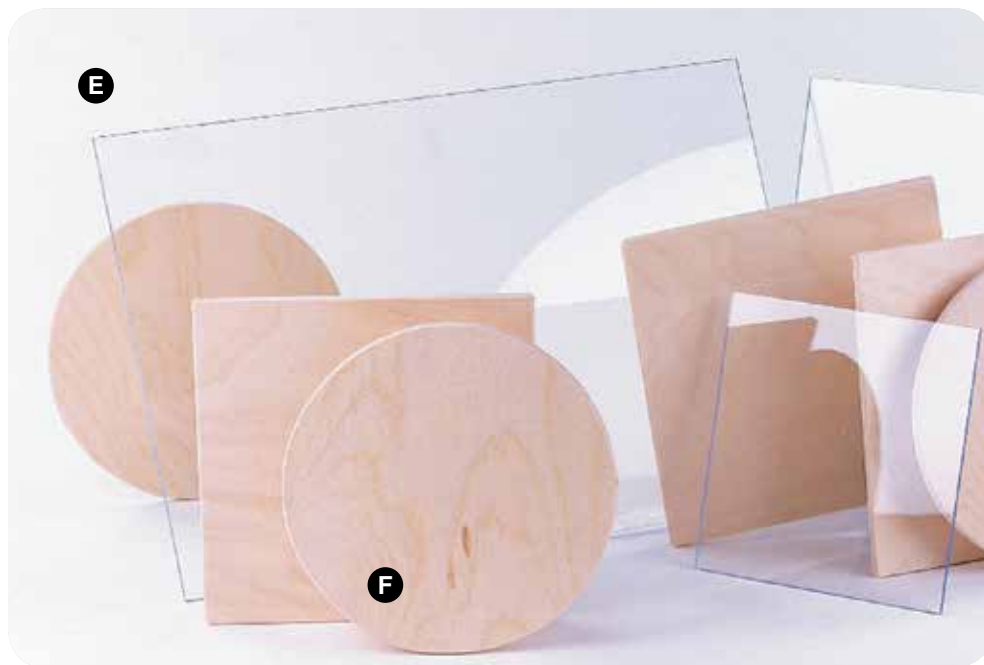

A Regular Styrofoam Assorted Shapes

Regular styrofoam assorted shapes, sold individually.
For collages and assembly.

Wreath \varnothing 23 cm	5⁵⁵	1490382
Egg 6.3 x 8.2 cm	1⁴⁰	1490242
Disc \varnothing 15.2 x 2.5 cm	2²⁵	1490234
Cube 10 cm	2⁹⁰	1490168
Cube 7.6 cm	1²⁰	1490150
Cones 102 x 228 mm	3⁹⁵	1490127
Cone 76 x 152 mm	1⁸⁰	1490101

B Regular Styrofoam Balls

Balls \varnothing 12.7 cm, Per unit	4⁴⁰	1490077
Balls \varnothing 10 cm, Per unit	2⁹⁵	1490069
Balls \varnothing 7.6 cm, Pack of 25	27⁹⁵	1490051
Balls \varnothing 6.3 cm, Pack of 50	36⁹⁵	1490044
Balls \varnothing 5 cm, Pack of 50	23⁹⁵	1490036
Balls \varnothing 3.8 cm, Pack of 100	28⁹⁵	1490028
Balls \varnothing 2.5 cm, Pack of 100	15⁹⁵	1490002

Smooth Surface Styrofoam

Smooth surface styrofoam, geometric solids.
Very easy to paint with tempera or acrylic.

C Eggs 50 mm	8⁸⁰	1490572
50 units pack.		
Eggs 71 mm	13⁹⁵	1490200
50 units pack.		
Eggs 100 mm	19⁹⁵	1490580
20 units pack.		
D Cones	13⁹⁵	1490218
\varnothing 6 x 14 cm high. Bag of 20.		
Balls – 76 mm	11⁹⁵	1490366
25 units pack.		
Balls – 63 mm	13⁹⁵	1490358
50 units pack.		
Balls – 50 mm	7⁷⁰	1490341
50 units pack.		

Balls – 38 mm

100 units pack. **10⁹⁵** 1490333

Balls – 25 mm

100 units pack. **3⁹⁰** 1490325

E Clear Acrylic

150 x 150 x 3 mm **4⁵⁰** 1231273
230 x 305 x 3 mm **9⁶⁵** 1231281

F Wood for Engraving

Square 178 x 178 x 7 mm thick **2⁹⁰** 1050228
Round \varnothing 178 x 7 mm thick **2⁹⁰** 1050236

Thermoplastic Modeling

in 5 easy steps!

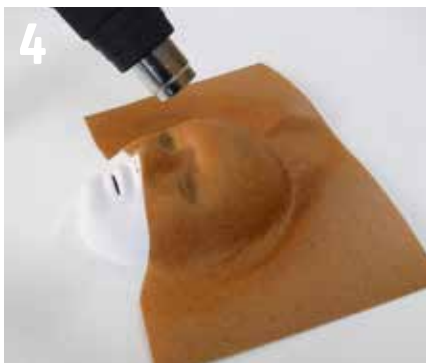
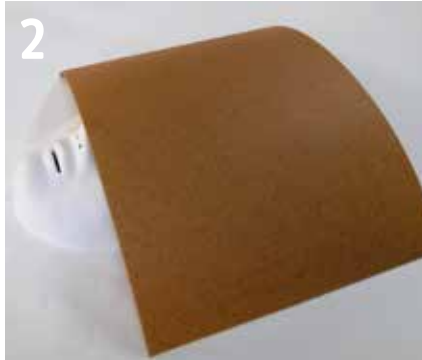

The result is surprising...
all you have left to do
is paint it!



A Worbla Thermoplastic

This thermoplastic modeling material can be shaped by hand without special safety equipment. It can take complex curves without requiring vacuum forming, and is self-adhesive when heated: no glue is required to join pieces. Shape the plastic however you want simply with hot air, water or steam. There's no waste, leftovers can be conditioned and totally re-blended and moulded to become just like putty. Many artists use Worbla instead of clay to create near-indestructible pieces. Non-toxic and skin safe. One leaf of 100 cm x 150 cm.

Age: 12 +

Finest Art	115⁹⁵	1212877
Black Art	119⁹⁵	1212885

A



B Heat gun

Heat Gun for Angled Swivel Glides Flexi-Felt (2121663).
16⁹⁵ 2121671

B



Tools

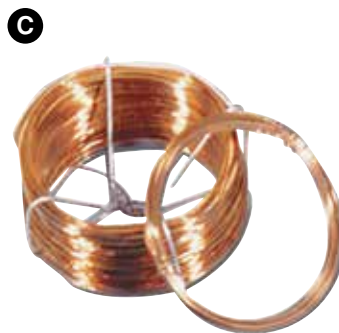
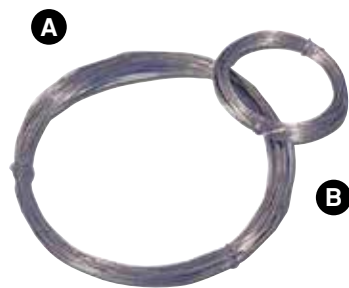

A Black Stovepipe Wire

15 m **2³⁵** 1205087
50 m **5³⁵** 1205947

B Wire in rolls

Galvanized wire in rolls.

15 m
14 gauge **6³⁰** 1205954
16 gauge **5⁶⁵** 1205962
30 m
18 gauge **5²⁰** 1205970

C Copper Wire

7.5 m **5⁴⁰** 1190362

D Wire in Rolls

Galvanized wire, in 4.5 kg rolls.

Wire in rolls **42⁹⁵** 1200617
14 gauge **36⁹⁵** 1200625
16 gauge **42⁹⁵** 1200633

E Safety Goggles

Industrial quality, for optimal protection.
Meets EN 166 standards.

2⁵⁵ 1340124

F Hollow Creative Wood-Burner

Wood-burner with four creative tips.

Maintains a 950° F temperature.

37⁹⁵ 1461755

G Junior Arrow JT 21 Staple Gun

Ideal for small jobs. Recommended staples:
Arrow 8 mm (see 3060423).

21⁹⁵ 3062288

H Arrow Staples

Box of 5000. 8 mm. For Junior Arrow JT21
staple gun (see 3062288).

12⁹⁵ 3060423

Pliers

Made of metal. Comfortable, non-slip handles.

I Electrician's Pliers
17.8 cm **7⁹⁵** 1340785

J Wire-cutter Pliers
15 cm **5²⁵** 1340819

K Long Nose Pliers

Made of metal. Comfortable, non-skid
handles. 20.3 cm

5²⁵ 1020668

L Measuring Tape

Plastic. Graduations in inches and
centimetres. 7.5 m

6⁷⁰ 1340850



A Metal Utility Knife – Large
Heavy-duty knife with retractable blade. Solid, metal grip. 18 mm blade.
7⁶⁵ 1160134

B Plastic Retractable Utility Knife – Small
Includes 1 snap-off blade with 12 sections and 1 blade-snapper. 9 mm.
1⁵⁰ 1160175

C Plastic Retractable Utility Knife – Large
Extra strong. Includes 1 snap-off blade with 7 sections. 18 mm.
7⁶⁰ 1160423

D Snap-off 9 mm Blade Cutter
Thin utility knife with a ratchet mechanism for blade release. 9 mm metal snap-off blades.
2⁴⁵ 1160431

E Metal Utility Knife with Retractable Blade
7³⁵ 1161991

F Craft Knife with Replaceable Craft Blade
Precision cutter with ceramic blade. The nylon textured handle ensures excellent grip and control, allowing precise cuts. The ceramic blade lasts 10 times longer than steel, does not rust, is non-conductive, safer to use and has a safe rounded tip. For left and right-handers. Blade is easy to change. Safety cap for the blade. One blade included.
18⁹⁵ 1121920

G Precision Ceramic Blade Cutter
Long lasting Micro-ceramic integrated blade stays sharpened. Good grip non-sliding finish. Non-rusting. Left and right handed.
14⁹⁵ 1160860

H Replacement Ceramic Craft Blades
Each blade is 32 x 6 x 0.65 mm. Pack of 4. Not shown.
26⁹⁵ 1161256

I Blade Refill
Blade refill for 1160191 utility knives. Pack of 10 blades.
3⁰⁵ 1161264

J Blade Refill – Large
Blade refill for 1160134 and 1160423 utility knives. 10 snap-off blades with 8 sections each. 18 mm.
3³⁰ 1161298

K Blade Refill – Small
Blade refill for 1160175 and 1160431 utility knives. 10 snap-off blades with 12 sections each. 9 mm.
2⁰⁵ 1161306

L Regular Knife ø 8 mm
With cap and universal sharp blade.
2⁸⁰ 1161629

M Universal Sharp-End Blades ø 8 mm
For regular knives. Pack of 10.
2⁹⁵ 1161736

N Wide Knife ø 12 mm
With cap and one blade.
5⁶⁵ 1161637

O Sharp Blades ø 12 mm
For large knives. Pack of 10.
4⁹⁵ 1161785

P Cutting Mats
Protects table tops and desk tops.
22 x 30 cm **6⁵⁰** 3174430
30 x 45 cm **10⁹⁵** 3174448
45 x 60 cm **21⁹⁵** 3174455

Scissors



A Children's Scissors – Plastic 13 cm

Plastic blunt end scissors with automatic return.
Age: 3 + **1⁶⁰** 1123207

B Children's Scissors – Plastic 13.3 cm

With automatic return.
1⁵⁵ 1120096

C Automatic scissors

The plastic strip provides automatic opening of the blades during the movement acquisition period. Once the child masters the motion, the strip can be pivoted aside, to use the scissors as usual. Blunt ends. 14 cm. Right-handed.

Age: 4 + **3⁹⁵** 1121235

D Children's Scissors – Blunt 12.7 cm

Right hand **2⁷⁰** 1120013

E Children's Scissors – Blunt 15 cm

Right hand
Age: 4 + **4⁵⁰** 1121458

F Sensoft 3D Scissors

Ergonomic, soft handles scissor. Specially designed for children's hands. Brush stainless steel blades produce a clean cut. Assorted colors. 13 cm.

Left Handed **3⁹⁵** 1121490

Right Handed **3⁵⁰** 1121482

G Children's Scissors – Blunt 13.3 cm

Right-handed.
3³⁵ 1120658

H Children's Scissors – Left-Handed Blunt

13.3 cm
Age: 3 + **3⁹⁵** 1120054

I Scissors – 13 cm

These ergonomic scissors have soft material inside the rings for optimal comfort. Safe round tips. Graduated stainless steel blades. Assorted colors. 13 cm.

2²⁵ 1121979

J Children's Scissors – Blunt 13.5 cm

Right-handed
Plastic Grip **1³⁵** 1120880

Scissors – Group Sets

Zenoa scissors combine aesthetics and comfort. Appealing with their blades with colorful patterns and comfortable with their soft material inside the rings. 13 cm (5 in.). Group sets, 12 pairs in a reusable storage case.

K Round Tips

Age: 4 + **34⁹⁵** 1121904

L Sharp Tips

Age: 6 + **34⁹⁵** 1121896

M Automatic opening scissors

Equipped with an exclusive automatic opening system, these ergonomic scissors are perfect for learning how to cut. Stainless steel blades provide an accurate cut. Safe blunt tips. 13 cm. Box of 10, assorted colours.

25⁹⁵ 1121912

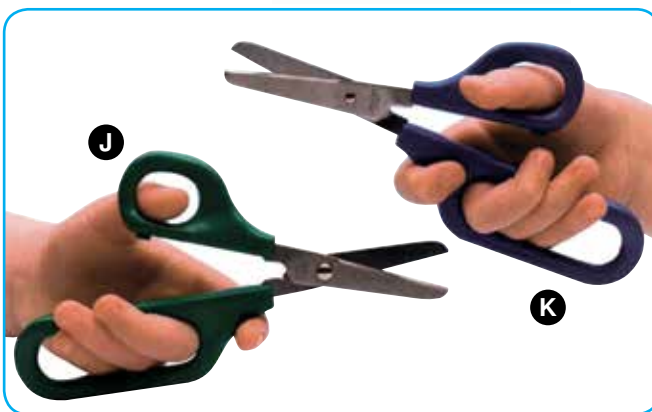

A Children's Scissors – Sharp

Right-handed. 14 cm

3⁴⁰ 1121136

B Children's Scissors – Blunt 15 cm

Right-handed.

Age: 4+ **5³⁵** 1120666

C Adults' Scissors – 16 cm

Here is a selection of quality scissors, to answer all your daily needs.

Age: 8+ **5⁵⁰** 1121128

D Children's Scissor – Sharp 16.5 cm

Right-handed.

Age: 8+ **4⁹⁵** 1120781

E Adult Scissors – 19 cm

Here is a selection of quality scissors, to answer all your daily needs.

Age: 8+ **5⁵⁰** 1120732

F Advanced Gel Scissors – 21 cm

Ergonomic scissors whose rings, made of innovative gel, allow a maximum of comfort, whatever the hold or the movements are. For left-handers and right-handers. Stainless steel blades and rivet. Techno and modern look. 10-year warranty.

5⁹⁵ 1121961

G Ultra Safe Kid's Scissors

The safe and effective scissors feature sharp blades, blunted tips and a clear plastic, permanent safety shield that the bottom blade slides in and out of, to prevent accidental mis-cuts. A spring automatically reopens the scissors, helping children with limited strength or coordination, and can also be folded in for regular use. Suitable for both hands.

6⁹⁵ 1123140

H Tutoring scissors

Blunt, 12 cm. Right-handed.

Age: 4+ **9⁷⁰** 1120039

I Easy Grip Scissors

To cut a variety of materials or help less-abled students. 20.3 cm

Age: 4+ **5⁸⁰** 1120807

Long Loop Scissors

Long loop handle allows the strength of middle, ring and little fingers to be used, whilst the index finger is placed outside the loop and used for guidance.

J Left Hand Green **17⁹⁵** 1120773

K Right Hand Blue **17⁹⁵** 1120609

Knives and Accessories

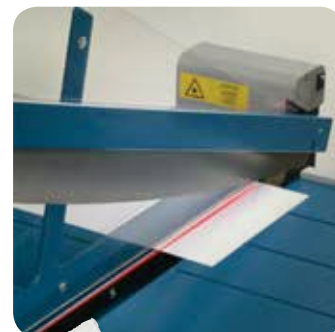
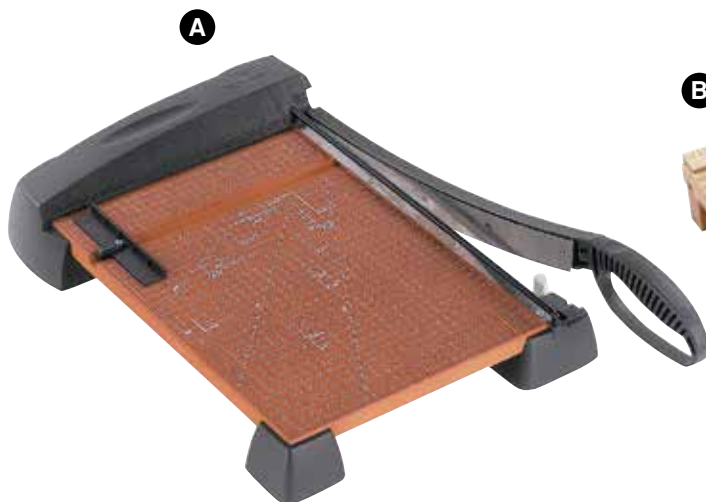

A X-Acto Paper Trimmers

Sturdy trimmers for paper and cardboard. Feature a quad-ruled wooden board and a plastic, adjustable guide.

38 cm **138⁹⁵** 3281326
61 cm **254⁹⁵** 3281342

B Hardwood Paper Trimmer

Heavy-duty paper trimmer. Square maple table. Quad-ruled surface with graduations. 15-sheet capacity. 61 cm.

489⁹⁵ 3280047

C Dahle Professional Rolling Trimmer

Trimmer features a sturdy metal base and an adjustable backstop. Self-sharpening, ground steel blade, encased in a plastic housing for safety, cuts in either direction. Cuts up to 12 sheets of paper at a time. Cut length is 72 cm. 91.5 x 36 cm.

493⁹⁵ 3280062

D Dahle 32 in. professional Guillotine

Large format professional guillotine designed to cut large amounts of paper with safety in mind. Features: acrylic safety shield for hands, spring system prevents blade from falling, self-sharpening blade made of German Solingen steel and maintains a perfectly honed edge every time it is used, automatic clamp holds material securely across the entire cutting surface, spindle driven adjustable guide, sturdy metal base with preprinted guides. The blade can be locked to prevent unsupervised use. Sits on top of a permanently mounted stand to ensure proper height and leverage for trimming. Cuts up to 30 sheets concurrently. Narrow strip cutting guide not included.

2,862⁹⁵ 3280096

Laser Guide Model

Features a laser guide to ensure that each cut is as accurate as possible. **3,093⁹⁵** 3280104



For institutional market: Drop shipment

A **B&B**



A B&B White Glue

Washable glue for various materials: paper, cardboard, wood, fabric. Non toxic.

118 ml	0⁹⁹	1131309
950 ml	5⁵⁰	1131432
3.83 L	16⁹⁵	1131440

B **B&B**



B B&B Eco Clear Glue Sticks

For paper, cardboard, fabric, polystyrene, and especially safe to use on photos. No wrinkling or crinkling. Strong adhesiveness. Made from cosmetic & pharmaceutical materials. Washable. No bleaching, acid-free, non-toxic, conforms to EN71 & ASTM D4236. 35 g.

Single unit	1³⁵	1121946
Box of 12	11⁹⁵	1121953

C Elmer's White Glue

For schools. Washable, non-toxic. Ideal for paper, fabric, wood.

36.9 mL	1⁰⁵	1130426
120 mL	1²⁰	1130483
225 mL	2⁵⁵	1130368
475 mL	3⁹⁵	1130376
950 mL	6²⁰	1130525
3.8 L	18⁹⁵	1130533

C



D



D Lepage White Glue

Non-toxic adhesive, ideal for paper, cardboard and wood.

150 mL	2⁵⁵	1130012
400 mL	7⁶⁰	1130038
800 mL	14⁹⁵	1130202
3 L	16⁹⁵	1130053

E Elmer's Purple School Glue Stick

Purple when applied, glue becomes clear when dry.

40 g	2¹⁰	1130194
------	-----------------------	---------

F Amos Glue Sticks

Non toxic.

8 g	0⁶⁰	1131911
22 g	1²⁵	1131937
35 g	1⁷⁵	1131945

E



F



G



H



I **B&B**



G Lepage Glue Sticks

Non toxic.

10 g	0⁸³	1130228
20 g	1⁴⁰	1130236
Glue stick 42 g	1⁹⁵	1130244

H Pritt Glue Sticks

Pritt Glue Sticks

10 g	1²⁵	1130459
22 g	1⁹⁰	1130434
42 g	2⁸⁰	1130442

I Earth-friendly school Glue Sticks

Box of 30 – 8 g sticks.

	22⁹⁵	1130848
--	------------------------	---------



Glue



A



B



C



D



E



F



G



H



I

A Crayola White Glue

With non-clogging tip. Non-toxic. Washable.
White glue 118 mL **1⁹⁵** 1131689
236 mL **3⁵⁵** 1131697

B Ultra Adhesive Glue

All-purpose glue. Non-toxic. For wood, glass, ceramic and plastic.
237 mL **5²⁵** 1131739

C Leelo Glue

Non-toxic, transparent glue. Applies cleanly and easily on paper or cardboard. 55 mL
0⁸⁶ 1131267

D Glue Brush

Glue brush. 16.9 cm
Dozen **7⁵⁵** 1212323

E Glue Spatula

Plastic spatula used to spread glue. 12 cm.
Pack of 10 **3⁷⁰** 1212315

F Elmer's Purple Spray Adhesive

The colour allows see the glue when applied, one can make sure to cover well all the necessary surface. Becomes transparent once dry. Ultra-resistant formula. Works on various surfaces. Solvent and acid free. Nontoxic. Gas-free spray. 236 ml.
9⁵⁰ 1142231

G Elmer's Gel Glue

Clear, odourless and flexible when dry. 120 mL.
1⁵⁰ 1131622

H Super 77 3M Spray Glue

Translucent, fast-drying spray adhesive. 467 g.
19⁹⁵ 1131259

I Elmer's Paper Mache Powder Glue

See-through, non-toxic glue will not grow mouldy. A 57 g box yields approximately 3 L of glue. Prepared glue and powder can be kept for a very long time.
5⁸⁵ 1130475

J Super Glue

Extra strong glue, which adheres to various materials. Fast drying. Does not flow. Warning : always use under adult supervision. Tube of 3 g.
6⁴⁵ 1131499

K Elmer's Rubber Cement

120 mL
3²⁰ 1130137

L Planatol Glue

Resin-based glue, used for bookbinding. 1.05 kg
35⁹⁵ 1130673



J



K



L

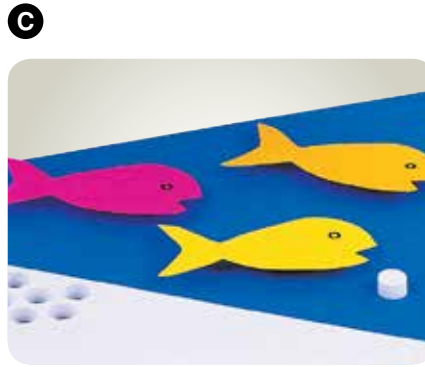

A Fun-Tack Adhesive Gum
Holds posters, papers, etc. Reusable. Replaces tapes and tacks. 56 g.
2⁴⁰ 1130210

B UHU Tac Adhesive Gum
Adhesive gum. Holds posters, papers, etc. Reusable. Replaces tapes and tacks. 60 g.
3⁶⁰ 1131168

C Appli-3D
Ø 10 x 8 mm, self-sticking (both sides) foam discs for 3D effects. Pack of 100.
5⁹⁰ 1206457

D Removable Mounting Squares
Double-sided removable squares for mounting and securing objects: posters, photos, artwork and other lightweight items. Use on wood, tile, painted walls, glass, and most other wall surfaces that are clean, dry and smooth. Adheres to painted cinder blocks, varnished wood, blackboards and glass. Weight capacity: 16 squares hold up to ½ pound. Pack of 64 squares.
4⁹⁵ 3391521

E Glue Sticks
All temperature mini glue sticks, 10 cm long. Pack of 25
Mini
Ø 7 mm **3²⁰** 1192921
Regular size
Ø 11 mm **6⁴⁰** 1192913

F Tall Glue Sticks
All temperature glue sticks. Measure over twice the regular size: 11 x 254 mm. Group pack: 2.26 kg box.
32⁹⁵ 1192939

G Mini Glue Gun
10 W mini glue gun. For mini glue sticks Ø 7 mm x 10 cm.
High temperature **7⁵⁰** 1192889
Low temperature **7⁵⁰** 1192897

H Dual Glue Gun
Dual temperature glue gun with high and low settings. 40 W. For glue sticks Ø 11 mm x 10 cm.
18⁹⁵ 1192905

Tape

A 



B 



C 



D 



E 

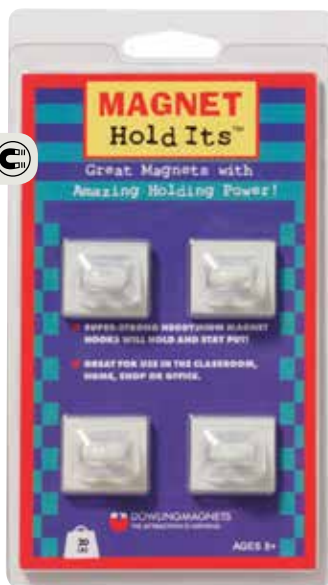

F



G



H



I

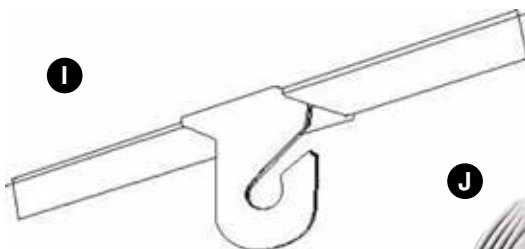

J



A Magnetic Adhesive Tape Dispenser

Magnetic adhesive tape dispenser with cutting lever. Refillable. Magnetic strength: 3 kg/30 cm. 14 mm x 4.5 m.

24⁹⁵ 1201797

Replacement Roll

4.5 m **14⁹⁵** 1201771

B Self-adhesive Magnetic Strip

Cut and apply easily to make a variety of small objects stick to any metal surface.

12 mm x 3 m **3⁷⁰** 2119659

12 mm x 30 cm **0⁹¹** 2110344

C Magnetic adhesive tape

Magnetic adhesive strip, in a convenient plastic dispenser. Magnetic strength: 730 g/30 cm. 20 mm x 8 m.

21⁹⁵ 1201748

D Self-adhesive Magnetic Strips

Apply these ready-to-use strips to make a variety of small objects stick to any metal surface 1 x 5 cm. Pack of 75.

8²⁵ 1210178

E Magnetic Ceiling Hooks

Pack of 4.

31⁹⁵ 1206499

F Double-Sided Adhesive Tape

Used to mount photographs and documents. 12.7 mm x 7.6 m.

8⁹⁵ 3390143

G Double-Sided Adhesive Tape

Used to mount posters, photographs and documents. 500 g/cm resistance.

24 mm x 50 m **11⁹⁵** 3391059

H Mounting Roll Tape

Double-sided, high density, durable, adhesive foam tape. 1.3 cm x 1.90 m.

4⁷⁰ 3390135

I Drop ceiling hangers

Heavy-duty, tempered aluminum. Pack of 2.

3⁹⁰ 3176492

J Velcro-Type Adhesive Strips

Includes one strip with loops and one strip with hooks, each 2 cm x 1 m. Used for presentations, exhibitions and other mounting purposes.

6⁹⁵ 1154004



Interlocking Tilt Modular Bin Unit

Modular unit features a unique interlocking design allowing you to mix and match sizes. Clear, removable bins keep supplies visible and tilt out effortlessly. Mounting hardware and labels included.

A 3 bins

Bins of $7 \frac{3}{8} \times 8 \frac{5}{8} \times 5 \frac{7}{8}$
 $23 \frac{5}{8} \times 9 \frac{1}{2} \times 7 \frac{3}{4}$ **99⁹⁵** 1121623

B 4 bins

Bins of $5 \frac{5}{8} \times 7 \frac{1}{2} \times 5$
 $23 \frac{5}{8} \times 8 \frac{1}{8} \times 6 \frac{5}{8}$ **89⁹⁵** 1121631

C 5 bins

Bins of $4 \frac{1}{4} \times 5 \frac{3}{4} \times 5 \frac{3}{4}$
 $23 \frac{5}{8} \times 6 \frac{1}{2} \times 5 \frac{1}{4}$ **54⁹⁵** 1121649

D 6 bins

Bins of $3 \frac{1}{2} \times 3 \frac{3}{4} \times 2 \frac{5}{8}$
 $23 \frac{5}{8} \times 4 \frac{1}{2} \times 3 \frac{5}{8}$ **29⁹⁵** 1121656

E 9 bins

Bins of $2 \frac{3}{16} \times 2 \frac{1}{2} \times 1 \frac{3}{4}$
 $23 \frac{5}{8} \times 3 \frac{5}{16} \times 2 \frac{1}{2}$ **23⁹⁵** 1121664

F Create-a-Space Storage™ Center

Appealing set of 8 wedge-shaped containers, with a convenient hand hole, placed around a round container, inside a \varnothing 30.5 cm tray. Perfect to store and organize arts and craft items such as pencils, scissors, glue sticks, etc. Plastic in bright colours.

22⁹⁵ 2099265

G Magnetic Create-a-Space™ Storage Bins

Designed to stand on their own or attach to a magnetic surface, these brightly coloured plastic storage bins are great for organizing your pens, pencils, art supplies and more. 5.08 x 9.52 cm high ea. Set of 4 bins with reusable write & wipe labels.

17⁹⁵ 2099257

H Single Tilt Bin Storage System

Stackable and can connect horizontally. Feature hinged, snap-tight lids. Can also hang on wall with the Mounting Bar (sold separately, see 1121698). White frame, transparent bin. "Patent Pending". 12 x 13.9 x 12.3 cm.

12⁹⁵ 1121680

I Mounting Bar for Single Tilt Bin®

For wall mount applications of the Stackable Caddy Organizer Canisters and Interlocking Single Tilt Bin®. Mounts easily to the wall. Can hold up to 40 pounds. Aluminum. Screws and anchors included. "Patent Pending".

11⁹⁵ 1121698

J 9-Canisters Rotating Organizer

Modular unit features six 3" and three 6" clear canisters with black snap-on lids. The base rotates in either direction. Get organized, stay organized. Use in home, office, or classroom.

45⁹⁵ 1121672

Stackable Caddy Compartments

Perfect for diverse storage needs. Feature hinged, snap-tight lids. Can also hang on wall with the Mounting Bar (sold separately, see 1121698) "Patent Pending".

K 10 x 10 cm **6⁹⁵** 1121714

L 20 x 10 cm **12⁹⁵** 1121722

M 33 x 10 cm **17⁹⁵** 1121730

N Stackable Caddy Organizer

Perfect for all storage needs. Designed to allow units to stack. Removable storage compartments feature hinged, snap-tight lids. Can also hang on wall with the Mounting Bar (sold separately, see 1121698) "Patent Pending". White frame and three clear containers (1) 11 x 11 x 10 cm, (1) de 22 x 11 x 10 cm and (1) 34 x 11 x 10 cm. Frame dimensions: 36 x 17 x 27 cm.

49⁹⁵ 1121706

Storage



A Caddies with Compartments and Handle

Take your supplies to the work station quickly and simply. Dishwasher safe. Assorted colours.

A Large – 2 Compartments

32.3 x 27.9 x 12.7 cm H. **5⁴⁵** 1142066

B Sorting cups

Set of 6 sorting cups for the Large Caddy. (1142066). Gray plastic. **7⁹⁵** 1142298

C Small – 3 Compartments

22.8 x 22.8 x 10.1 cm H. **4³⁵** 1141993

D Microban Scissor Caddy

Lets you put the scissor pots on team tables, before putting them away. Scissors not included. 35 x 22 x 16 cm

24⁹⁵ 1204593

E Tiny Tub Caddy

Wire caddy features six small, removable containers, each measuring 6 x 11 x 9 cm. Caddy measures 35 x 22 x 16 cm. Sold empty.

23⁹⁵ 1140623

F Empty Plastic Box with 12 Sections

12-compartment plastic box, perfect for organizing and storing all very small objects. 27 x 18 x 4 cm.

7⁹⁵ 1192699

G Storage Boxes with Lids

Plastic. 29.5 x 13.5 x 10.5 cm. Pack of 6.

22⁹⁵ 1204049

H Hinged Storage Box

Plastic. With hinged lid. Great for pencils, stickers and other small objects. 20 x 14 x 5 cm.

4⁰⁵ 1141423

A Documents Storage Bins

These bins hold books, magazines, files, folders, etc. Sides connect together. The front and rear handles allow easy gripping, even with little hands. Clear pouches included for labelling. Made of sturdy and drop resistant plastic. Available in bright colours.

Letter size
5 bins of 11 in. **15⁹⁵** 1142025

Legal size
5 bins of 14 in. **18⁹⁵** 1142009

B Bin Racks

Made of epoxy coated steel for great durability. The bin will not tip over when placed in the rack, even when overloaded with books. Fits on desktops or on 38 cm shelves. Can be wall mounted (hardware not included).

Letter Size (for bins: 1142009) **27⁹⁵** 1142280
Legal size (for bins: 1142025) **29⁹⁵** 1142272

C Adhesive Label pockets

Adhesive clear label pockets. Just peel and stick for instant labelling.

C 5 x 7.6 cm. Pack of 6 **3⁵⁰** 1142256
D 7.6 x 12.7 cm. Pack of 4 **4⁵⁰** 1142264

E Storage Cubes with Clear Lid

Easy to grip handles are perfectly sized for big and small hands. Made of impact resistant plastic. Clear lid. Capacity of 15 L. 34.5 x 28.4 x 20 cm.

Blue **9⁹⁵** 1142363
Green **9⁹⁵** 1142371
Red **9⁹⁵** 1142389

F Stack'N'Nest Container

This heavy-duty, plastic bin is cleverly designed to be stacked or nested. 38 x 31 x 15 cm

11⁹⁵ 1141258

G Grey Storage Tray

48.5 x 40.5 x 10 cm. Plastic. **13⁹⁵** 1140672

Storage



A Mini Crate

Bring the convenience of crate storage to your desktop. It features the interlocks on all 4 sides to create a customized and unique modular desktop storage solution. Solid bottom keeps smaller components contained. Organize your workspace efficiently and economically. Item Dimensions: 9 L x 7.75 W x 6 H. Assorted colours.

3²⁵ 1142041

B Storage Bins

or transparentSturdy plastic, in 4 bright colours or transparent.

	33.5 x 19.5 x 13.5 cm	39.5 x 33.5 x 13 cm
Blue	1141605	1141860
Clear	1141977	1141985
Green	1141621	1141886
Red	1141597	1141852
Yellow	1141613	1141878
	3³⁵	6⁴⁵

C Plastic Storage Bins

With cover.

28 x 17 x 7 cm	5²⁰	1141894
35 x 28 x 8 cm	9⁴⁰	1141910

D Translucent Storage Box with Lids

Flexible plastic boxes, designed to be stacked. Practical and unbreakable. Ideal solution to all your storage needs.

17 x 13 x 7 cm	2⁵⁰	1141829
33.5 x 20.5 x 12 cm	4³⁵	1140417
41 x 29.5 x 17.5 cm	9³⁰	1140425
58 x 43 x 15 cm	19⁹⁵	1140888

E Storage Tubs with Lids

Clear plastic tubs for easy viewing of contents. Available in several sizes. Stack and store away in seconds. Handles click tightly to fasten the lid.

28 x 41 x 17 cm	10⁹⁵	1142082
40 x 60 x 17 cm	21⁹⁵	1141084
40 x 60 x 34 cm	25⁹⁵	1142090

F All-Purpose Bin

37 x 31 x 14 cm.

5⁹⁵ 1140631

G 3-Drawer Organiser

Sturdy plastic. Translucent drawers. 34 x 29.5 x 24.5 cm.

21⁹⁵ 1141753

H Storage Cubes with Clear Lid

The Storage Cube is perfect to store your letter or legal hanging files and folders or to organize any space. Stackable, even with the cover on. Made of durable plastic. The lid snaps on tight. 43.6 x 36 x 26.6 cm.

Blue	19⁹⁵	1142330
Green	19⁹⁵	1142348
Red	19⁹⁵	1142355

I Roughtote storage box

Extra high storage box. 61 x 47 x 51 cm

32⁹⁵ 1142157

A

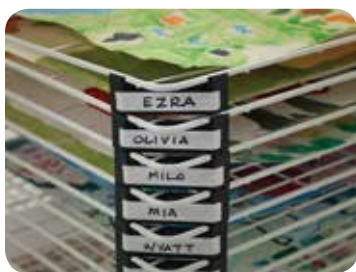

B



C



D



E



A Mobile Drying Rack

That floor mobile metal drying rack features 20 shelves with rounded corners, to dry or store up to 20 drawings and paintings. Lock down bar secures racks in place. Rack spacers can be personalized with student names. A removable paint drip tray to protect classroom floors from spills. 5 cm locking casters for mobility and stability. 62 x 53.2 x 77 cm.

382⁹⁵ 1020270

B Table-Top Dryer/Storage Rack

Can be used as drying or storage rack. Structure made of steel wire and welded for extra durability with a hard, light blue enamel finish. Comes fully assembled and ready to use. 34 kg. Features 50 shelves 22.8 x 41.9 cm. Base: 46 x 51 cm. Width: 42 cm. Height: 81 cm.

339⁹⁵ 1026210

C Wall Drying Rack

Metal drying rack features 20 shelves with rounded corners, to dry or store up to 20 drawings and paintings (40 x 50 cm). Wall mount at the desired height. 51 x 41 x 85 cm.

173⁹⁵ 1020072

D Cardboard Display Rack

Metal wire display rack stands horizontally or vertically. Holds up to 300 cardboard sheets. 58 x 73 x 49 cm.

214⁹⁵ 3281540

E Tissue Paper Rack

Holds 40 packs of 24 sheets of tissue paper. 55 x 40 x 40 cm.

124⁹⁵ 1200054

Storage

A

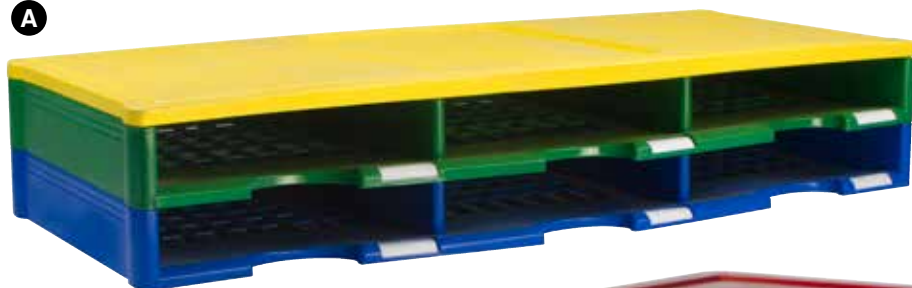

B



C



D



E



A Paper organizer with 6 compartments

That durable yet lightweight organizer has 6 compartments with an integrated label holder on each compartment. Stackable up to 12 units high. Each compartment measures 9.5" wide x 12" deep (22.86 x 30 cm). Sturdy plastic.

49⁹⁵ 1142017

B Quick stack organizer

That durable yet lightweight organizer has 6 compartments with an integrated label holder on each compartment. Ideal for letter size paper. Sturdy plastic 15.6"d.x 20.375"w. x 11.75"h.

32⁹⁵ 1142074

Paper Storage System

Sturdy cardboard box. Accommodates sheets of paper up to 22.8 x 30.5 cm. Paper not included.

C 15 Compartments **49⁹⁵** 1200609

D 10 Compartments **64⁹⁵** 1200658

E Storage Box

With 12 compartments. Wood. 33.5 x 23 x 30.5 cm. Sold empty.

77⁹⁵ 2040236

A



B BB B?



C BB B?

**A Storage Racks with Clear Bins**

Modular shelves with powder-coated steel frame for durability. Transparent resistant plastic bins, which allows to see the contents. Easy assembly.

12 bins
15 bins

299⁹⁵ 1142314
343⁹⁵ 1142322

B Storage Box for Cardboard

Vertical wooden storage box for 55.8 x 71.1 cm (22 x 28") cardboard. Made of sturdy lacquered birch plywood. Three removable thick Masonite dividers slide in the grooves. Full-length hinge, handle and retention chain for the lid. Side and top handles. Size: 82.5 x 62 x 22.8 cm. Cardboard sold separately.

299⁹⁵ 1212208

C Wooden Storage Cart

Handy storage cart made of very sturdy birch wood. 3 fixed shelves with raised edges and sturdy wood handle for easy relocation. Spacious storage areas for large-size papers, and rubber casters. Easy assembly. 53 x 86 x 81 cm high.

349⁹⁵ 2005478

A **B²**

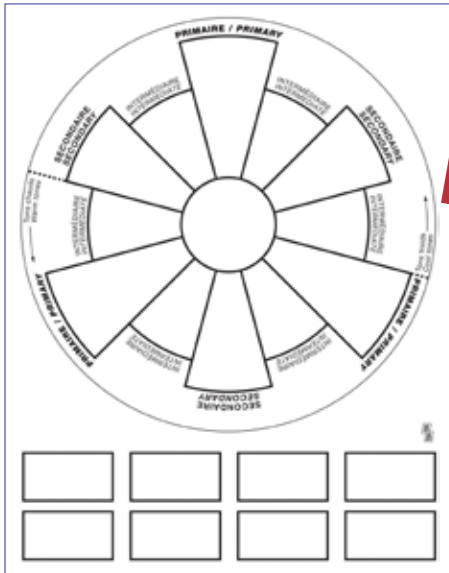

B **B²**

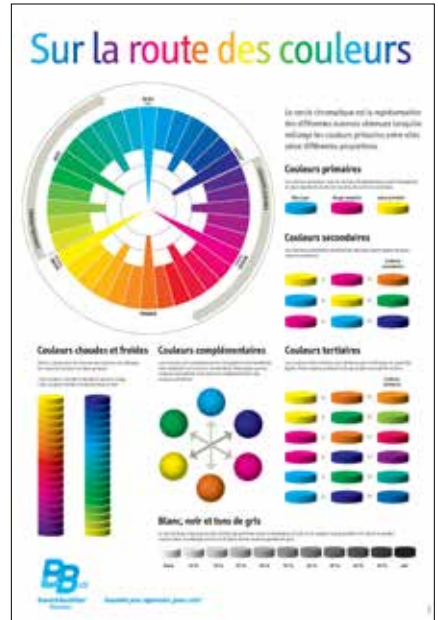

Hint from B²

The three primary colours (cyan, magenta, primary yellow) allow for the creation of all the other colours of the chromatic colour wheel. The purity of the primary colours is essential, and should not include any trace of the two other colours.

C **B²**

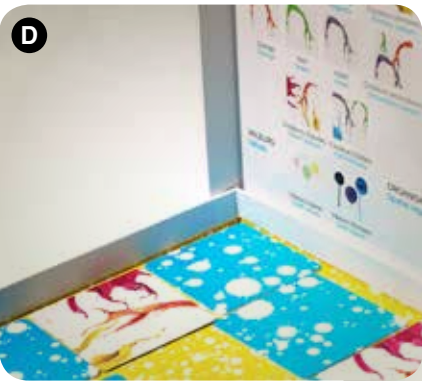

D



A Chromatic Colour Wheel Template

Blank, chromatic circle template. Can be painted with primary colours. Helps to learn and understand primary, secondary and tertiary colours. Printed on rigid white cardboard; a high quality gouache like Miracolor is recommended (see 1254853). Pack of 30. 21.6 x 28 cm.

8⁹⁵ 1201813

B CMY Colour Theory Posters

Reference poster on colours and combinations. In French. 55.8 x 81.2 cm.

French **6⁹⁵** 1209329
English **6⁹⁵** 1209311
 Not shown.

C Make-Your-Own Portfolios Kit

Storage solution for drawings, sketches and artwork. Highly rigid, white cardboard sheets (6 ply). Can be painted or decorated. Easy to assemble. Can contain up to 100 regular cartridge sheets 30.5 x 45.7 cm. Set of 25 pre-printed cardboard with an instruction sheet.

39⁹⁵ 1202217

D Memory Game Introduction to Visual Arts

Progressive memory game allowing to learn artistic concepts in the Education Program! The cards are spread face down on a table. In turn, players turn two cards. If they are identical, the player keeps them and continues. When there are no more cards, the player that has the most wins. 4 ways to play. Includes 48 cards illustrating 24 elements of the plastic language, a washable box with illustrated bilingual lexicon and rules.

Age: 4+ **29⁹⁵** 2036325



Hint from **B²**



For art students and teachers alike, the "cahier de traces" is a unique system promoting a more structured process of creation and evaluation. In this section, you will find several teaching tools with colour illustrations on glossy paper, on a variety of subjects including orientation and artistic notions. The tools also include a timeline of various art movements.

The "cahier de traces" allows teachers to track and assess the artistic work and progress of their students on a top-quality cartridge paper. This initiative was launched to address the guidelines set by the Éducation, Loisir et Sport Québec, requiring the creation of a tool to track a student's progress through documentation and diversified and relevant reference sources.

The "cahier de traces" is a local initiative compliant with the standards of Éducation, Loisir et Sport Québec. The product is exclusive to Brault & Bouthillier, thanks to its creators, Michelle Lefebvre and Patrick Touchette, and the Commission scolaire de la Capitale.



A Cahier de traces pour le secondaire

"Cahier de traces" for all levels of high school. Complies with all requirements set by Éducation, Loisir et Sport Québec, this tool makes it possible to track a student's progress through documentation and diversified and relevant reference sources. 100 pages, 9" x 12" coil binding landscape orientation. Improved, wider coil for easier handling and better preservation of sheets. 80 pages of cartridge paper 70 lb and 19 pages of relevant reference sources. Available in French only.

High School – 1 st year	8⁹⁵	1500503
High School – 2 nd year	8⁹⁵	1500511
High School – 3 rd year	8⁹⁵	1500529
High School – 4 th year	8⁹⁵	1500537
High School – 5 th year	8⁹⁵	1500560

**A Basic Handicraft Kit**

Plastic container filled with pompons, pipe cleaners, sequins, moving eyes, feathers, buttons, and much more.

29⁹⁵ 1204023

B Giant Treasure Chest

Wonderful collection of collage materials, including sticky shapes, coloured pasta, painting sponges, buttons, mosaic pieces, beads, laces, burlap, yarn, wooden shapes, tissue paper hair, gummed paper and a variety of papers.

82⁹⁵ 1200047

C Shredded Paper

Shredded paper for handcraft. 100 g bag.

Assorted colors

Shredded paper for handcraft. Yellow, purple, pink, red and green. 500 g bag, 100 g of each colour.

15⁹⁵ 1131085

D Cotton Wool

454 g roll.

Not shown. **16⁹⁵** 1201029

Regular size. 300 units pack.

White **1⁶⁵** 1201037

Triple size balls. 100 units packs.

Blue **5⁶⁵** 1202449

Pink **5⁶⁵** 1202456

Yellow **5⁶⁵** 1202407

Pipe Cleaners and Pompoms



Fantasy Pipe Cleaners

Assorted colours. 30 cm long.

A 2 Colour Twist

Assorted colours, bag of 50. **3¹⁵** 1212307

B Oval

Pack of 50. **2⁴⁵** 1020551

C 2 Colours

Assorted colours, bag of 100. **2⁹⁰** 1212299

D Metallic

Pack of 100. **3¹⁵** 1201425

E Pipe Cleaners

Boxes of 100. 30 cm.

Assorted colours **2⁰⁰** 1200864

Black **2⁰⁰** 1200922

Brown **2⁰⁰** 1200906

Dark blue **2⁰⁰** 1200880

Green **2⁰⁰** 1200971

Light blue **2⁰⁰** 1200898

Orange **2⁰⁰** 1200930

Pink **2⁰⁰** 1200955

Purple **2⁰⁰** 1200948

Red

2⁰⁰ 1200963

White

2⁰⁰ 1200872

Yellow

2⁰⁰ 1200914

F Assorted Neon Colours

2⁰⁰ 1121789

Short Pipe Cleaners

Boxes of 100, 15 cm.

Assorted colours. Not shown. **1⁴⁵** 1200989

White. Not shown. **1⁴⁵** 1203595

Jumbo Pipe Cleaners

Packs of 50. ø 15 mm x 30 cm. Not shown.

G Pack of 25, in assorted colours. 30 mm x 45 cm. **16⁹⁵** 1209576

H Assorted Colours **3¹⁰** 1202415

Metallic Colours. Not shown. **4¹⁰** 1190040

Pompoms

Assorted size and colour pompoms.

I ø 25 mm **4³⁵** 1202423

100 pompoms.

J Assorted Sizes

Bag of approx. 1000 pompoms. **19⁹⁵** 1202894

K Assorted sizes

Neon colours. 100 units pack. **3²⁵** 1121797

Solid Colours Pompoms

Bags of 100 pompoms of the same colour. Not shown.

Black **2⁹⁵** 1212232

Kelly Green **2⁹⁵** 1210368

Pink **2⁹⁵** 1212273

Purple **2⁹⁵** 1212281

Red **2⁹⁵** 1210350

Royal Blue **2⁹⁵** 1212240

White **2⁹⁵** 1210343

Yellow **2⁹⁵** 1212265

L Metallic Pompoms

Bag of 75 metallic pompoms in assorted sizes.

5⁷⁵ 1190057

M Glitter Pompoms

Bag of 100 pompoms in assorted colours. ø 13 mm.

6⁸⁵ 1207596

Rubber Foam



Rubber Foam Shapes

A Flowers Assorted sizes

120 units bag. **3³⁵** 1191139

B Wild Animals

120 units bag. **3³⁵** 1191147

C Large Size Fruit

48 units bag. **3⁰⁵** 1191154

D Halloween

54 units bag. **5⁹⁵** 1191162

E Easter

Bag of 60 assorted shapes. **1⁸⁵** 1202027

F Snowmen

Bag of 64 pieces in assorted sizes. **2¹⁵** 1202043

G Snow Flakes

Bag of 64 pieces in assorted sizes. **2¹⁵** 1202050

H Christmas

Bag of 60 assorted shapes. **2¹⁰** 1202068

I Hearts

Bag of 120 pieces in assorted sizes and colours. **1⁷⁰** 1490226

J



J Foam Shapes

Large assortment of soft, thin, foam rubber shapes, in a variety of sizes and colours. Ideal for all arts and crafts projects (collages, posters, greeting cards, murals, and more). **13⁹⁵** 1204544

Rubber Foam Sheets

Packs of 10 sheet. 23 x 30 cm x 2 mm.

K Wavy **5⁹⁵** 1121862

L Plain **5⁵⁰** 1205905

30 x 46 cm. **10⁹⁵** 1201961





E

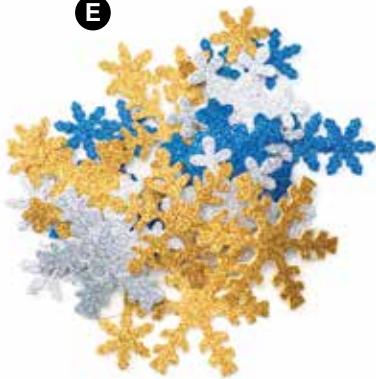

F



G



I



Self-adhesive foam shapes

These thematic foam sticker sets allow children to become familiar with the fauna and flora.

- A** Insects – 72 pk. **2³⁵** 1193598
- B** The sea – 64 pk. **2³⁵** 1193572
- C** Tulips – 60 pk. **2³⁵** 1193580

D Self-Sticking Rubber Foam Shapes

Assortment of 164 self-sticking rubber foam shapes – vehicles (36 shapes), insects (72 shapes), musical instruments (56 glitter shapes).

8⁷⁰ 1203272

Adhesive foam shapes

Assorted quantities, sizes and colors.

- E Glitter Snowflakes**
Bag of 72. **8²⁰** 1191105
- F Glitter Hearts**
144 units bag. **4⁰⁰** 1191113
- G Glitter Stars**
Bag of 120. **7⁸⁰** 1191121

H Geometric shapes

360 pieces. **5⁰⁵** 1203405

Self-adhesive foam sheets

Foam sheets of different colours. 9 x 12 in. (23 x 30 cm).

- I Plain**
10 colours. **5⁵⁰** 1121854
- J Glitter colours**
6 colours. **5⁹⁵** 1090018

Decorations

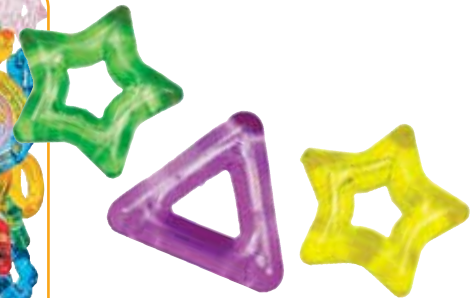
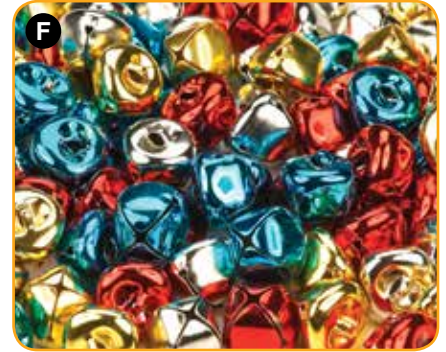
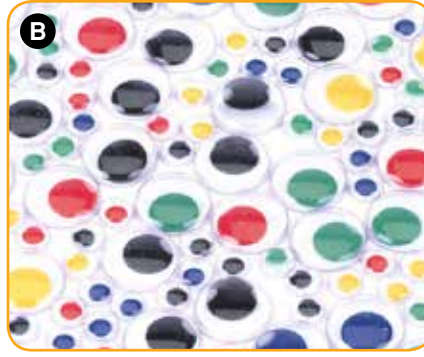

A Black Moving Eyes
Pack of 100.
Round
ø 7, 10 and 15 mm. **1⁶⁵** 1201235
Oval
ø 10, 12 and 15 mm. **2⁶⁰** 1206077

B Assorted Googly Eyes
Assorted sizes and colours. Pack of 100.
2⁶⁵ 1208677

C Googly Eyes with Lashes
Bag of 100 moving eyes 7 or 10 mm, with lashes.
3⁸⁰ 1203397

D Wiggly Eyes Neon assorted Colours
15 mm
Bag of 80. **3²⁵** 1121821
20 mm
Bag of 50. **3³⁵** 1121839
20 and 30 mm
Bag of 20. **3³⁵** 1121847

E Feathers
Assortments of feathers in a variety of colours and sizes.
28 g **4²⁰** 1202431
100 g **12⁹⁵** 1201565

F Jingle Bells
Bag of 100 jingle bells, 15 mm each.
6⁸⁵ 1203413

G Assorted Gems
Variety of colours, sizes and shapes.
250 g bag. **12⁹⁵** 2310597

H Fancy Stringing Rings
Exciting transparent colours in fun shapes! Bag of 113 g. Approximately 1.5 cm in diameter.
7¹⁵ 2311157

I Jumbo Buttons
Assorted shapes. Pack of 120.
Approx. ø 5 cm. **15⁹⁵** 1208768

J Craft Buttons
450 g assortment. **9⁹⁵** 1206069

K Stringing Straws
Set of 218 – 2.5 cm straws, in 5 bright colours. **5³⁰** 1208842

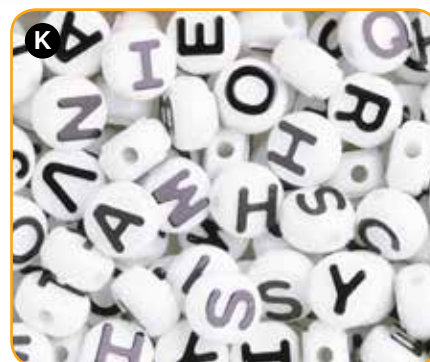
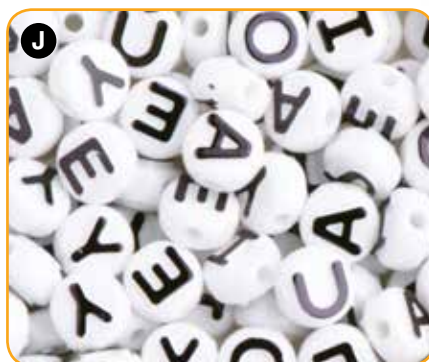

Giant Wooden Beads

24 mm, 100 beads in a pack.

- A** Natural wood **23⁹⁵** 2310159
- B** Coloured wood **23⁹⁵** 2310167

C Assorted Beads Value Pack

454 g bag of assorted beads. **9⁹⁵** 2310712

D Sports Pattern Bead Bag

Bag of 100 beads in 5 assorted, sports-related shapes.

7⁹⁵ 2310605

E Coastal Beads

150 g bag.

8⁹⁵ 1191188

Plastic Beads

F Plastic beads

1000 beads/bag, 5 x 7 mm.

3⁶⁵ 2310183

G Plastic beads

6 x 9 mm

5⁹⁵ 2310191

H Neon colors

6 x 9 mm

8⁹⁵ 1191170

I Large Plastic Beads

Bag of 250 large plastic beads in 5 bright colours. The size of the holes facilitate threading. 10 x 12 mm.

8²⁰ 1193150

Letter Beads

113 g bag with approximately 350 – 1 cm beads.

- J** Alphabet **17⁹⁵** 2310274
- K** Vowels **25⁹⁵** 2310282

Glitter and Coloured Sand



A Holiday Sequins

Assortment of 4 holiday-themed sequin bags: Easter, Christmas, Halloween and snowflakes. Each bag weighs approximately 28 g.

7⁸⁵ 1203330

B Sequin flakes

Assorted colours—70 g
Assorted colours—400 g
Black and White—70 g
Black and White—400 g
Blue and White—70 g
Blue and White—400 g
Purple and Blue—70 g
Purple and Blue—400 g

5²⁰ 1193093
17⁹⁵ 1193051
5²⁰ 1193101
17⁹⁵ 1193069
5²⁰ 1193085
17⁹⁵ 1193044
5²⁰ 1193119
17⁹⁵ 1193077

C Glitter

	12 g	112 g	454 g
Blue	1210822	1210913	1211291
Copper		1193564	1193556
Gold	1210848	1210939	1211267
Green	1210830	1210954	1211309
Multicoloured	1210863	1210962	1211317
Red	1210814	1210947	1211283
Silver	1210855	1210921	1211275
	0⁷²	2⁹⁵	13⁹⁵

D Fancy Sequins

Fancy sequins in assorted shapes and sizes.
113 g **6⁵⁰** 1211242

E Coloured Sand

Container with special pouring lid. 200 g.

Beige	2²⁵	1206242
Black	2²⁵	1206267
Dark blue	2²⁵	1206234
Green	2²⁵	1206325
Light blue	2²⁵	1206226
Mauve	2²⁵	1206291
Orange	2²⁵	1206275
Pink	2²⁵	1206309
Red	2²⁵	1206317
White	2²⁵	1206218
Yellow	2²⁵	1206259

F Cardboard for Coloured Sand

Self-adhesive cardboard, for coloured sand. 20 x 30 cm.
Pack of 5. **6⁷⁰** 1201664



A Glitter Glue

Glitter glue with 3D effect. Washable and non-toxic. 236 mL bottle.

Blue	4³⁰	1130301
Gold	4³⁰	1130277
Green	4³⁰	1130319
Multicoloured	4³⁰	1130327
Orange	4³⁰	1130384
Purple	4³⁰	1121805
Red	4³⁰	1130293
Silver	4³⁰	1130285
Yellow	4³⁰	1130392

B Amos Glitter Glue Set 5 different colours

5 bottles, 120 mL each.

23⁹⁵ 1131929

C Glitter Glue – Group set

Set of 50 – 10.5 mL tubes. Assorted colours.

37⁹⁵ 1131952

D Crayola Glitter Glue

5 – 9.8 g tubes, assorted colours.

2⁷⁰ 1130400

Elmer's Coloured Transparent Glue

Transparent coloured glue, ideal for any creative projects. Washable and nontoxic. 147 ml.

E Pink	4⁸⁰	1142199
F Blue	4⁸⁰	1142207
G Purple	4⁸⁰	1142215

Elmer's Glow in the dark Glue

Once exposed to the light, it becomes phosphorescent! Perfect for collage, painting, slime, and more! Washable. 147 ml.

H Natural	8⁵⁰	1142165
I Blue	8⁵⁰	1142173
J Pink	8⁵⁰	1142181

K Elmer's Clear Glue

Transparent glue, ideal for any creative projects. Washable and nontoxic. 946 ml.

9³⁰ 1142223

Wooden Accessories

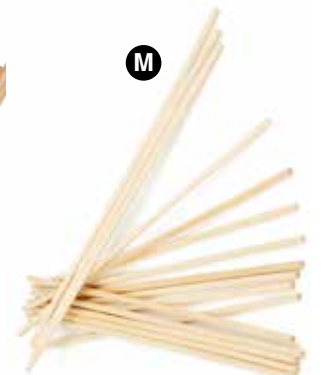
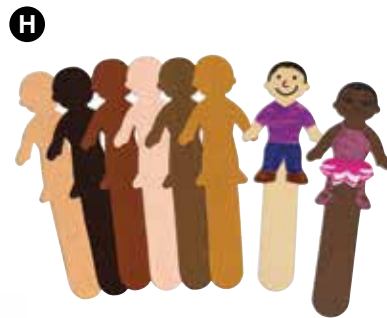

A Assorted geometric shapes

1000 wooden pieces measuring from 1 x 1 cm to 2 x 5 cm.

27⁹⁵ 1203389

B Round Toothpicks

Made of wood. Assorted colours. Box of 250.

2⁷⁰ 1201102

C Flat Toothpicks

Made of natural wood. Box of 650.

1²⁰ 1201128

D Cork Stoppers

Assortment of 120 in assorted sizes.

9⁶⁰ 1201706

E Tongue depressors

Multi-purpose flat, wide sticks, useful as levers and axles when building models, as handles for puppets, and much more. Wood. Box of 250.

7⁸⁰ 1200013

F Coffee Stir-Sticks

Box of 1000.

3²⁵ 1200260

G Coloured Coffee Stir-Sticks

Assorted colours. Bag of 200 sticks.

3²⁵ 1207604

H Skin Tone Kids Craft Sticks

Make little kid characters with these craft sticks in six different skin tones. Pack of 24.6 x 18 cm.

7⁵⁵ 1203603

I Wild Animal Craft Sticks

Craft sticks in five different wild animal designs. Pack of 50.3 x 18 cm.

7⁵⁵ 1203553

J Mini wooden clothespins

This set of 50 mini wooden clothespins in varied colours allows children to match the colors while developing fine motor skills.

1⁹⁵ 1193531

K Clothespins

Wood. Box of 50.

2⁸⁵ 1201185

L Wooden Dowels

Dowels used to build mobiles, puppets and a variety of structures. 60 cm long.

3, 5, 6, 8, 9 and 11 mm

Set of 12. **13⁹⁵** 1201607

3 mm

Set of 6. **3⁹⁵** 1202761

5 mm

Set of 6. **6⁵⁵** 1202779

M Wood Dowels

Measure approximately 30 cm x 5 mm. Bag of 16.

3¹⁰ 1121813

Paper Plate, Cups and Bags



A Aluminium Plates

Pack of 100.

76 mm	8⁹⁵	1200161
100 mm	15⁹⁵	1200179
127 mm	19⁹⁵	1200187
200 mm	29⁹⁵	1200195
230 mm	45⁹⁵	1200203

B Paprus Rigid Cardboard Plates

Available in different sizes and packs.

150 mm 100 pack	8²⁵	1201094
150 mm 1000 pack	76⁹⁵	1200229
200 mm 100 pack	13⁹⁵	1201110
200 mm 500 pack	62⁹⁵	1200237
230 mm 100 pack	16⁹⁵	1201136
230 mm 500 pack	74⁹⁵	1200245

C Thin paper plates

Packs of 100.

ø 22.8 cm **6¹⁰** 1206044

D Paper Doilies

Packs of 100 (approx.).

20 cm	6⁹⁵	1206093
15 cm	4²⁵	1206085

E Cups

Paper 198 mL
Pack of 100. **12⁹⁵** 1140813

Paper 118 mL
Pack of 200. **4³⁰** 1140839

Paper 227 mL
Pack of 250. **38⁹⁵** 1140821

Styrofoam
Pack of 50. 198 mL **1⁸⁰** 1140771

F Paper Containers

Fits the B&B 6 cavity tray (see 1141134).

Pack of 250. ø 64 mm. 118 mL. **11⁹⁵** 1141233

G Cardboard tubes

Pack of 8. ø 4 x 52 cm. **7³⁰** 1201292

H Kraft Cardboard Rolls

Pack of 12 rolls of Kraft paper. 11.5 cm. **3⁹⁰** 1193549

I Cardboard Spools

Empty spools. Pack of 20. 7 x 17 cm. **3⁹⁵** 1206630

J White Paper Bags

15 x 9 x 28 cm. Pack of 50. **15⁹⁵** 1207018

K Brown Paper Bags

Packs of 100.

88 x 50 x 170 mm
454 g (1 lb) **3⁹⁵** 1203025

100 x 64 x 190 mm
900 g (2 lbs) **3⁵⁰** 1203033

130 x 88 x 267 mm
5.44 kg (12 lbs) **4⁹⁵** 1203058

155 x 96 x 318 mm
3.63 kg (8 lbs) **6¹⁵** 1203082

165 x 100 x 330 mm
4.54 kg (10 lbs) **6⁹⁰** 1203090

178 x 110 x 340 mm
5.44 kg (12 lbs) **8⁵⁵** 1203108

200 x 127 x 406 mm
9.07 kg (20 lbs) **9⁹⁵** 1203124

L Coloured Paper Bags

In 7 assorted colours. Packs of 28.

105 x 203 mm **8⁵⁰** 1206424

150 x 280 mm **10⁹⁵** 1206416

Frames and Stencils

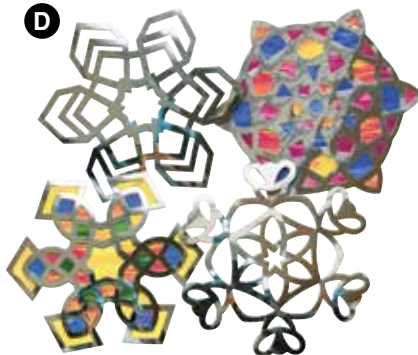

A Plain Cardboard Frames

White cardboard frames to be painted and decorated.
Pack of 12.

22 x 30 cm **21⁹⁵** 1206861
30 x 45 cm **26⁹⁵** 1206879

B Plain Cardboard Frames

Various size pre-cut white frames, to be decorated creatively.
From 10.2 x 15.3 cm to 45.7 x 61 cm. Pack of 60.

68⁹⁵ 1200690

Stained-Glass Shapes

Stained-glass shapes in assorted themes. Sets of 24.
15 x 15 cm.

C Nature **7¹⁵** 1201581
D Silver Snowflakes **12⁹⁵** 1201599
E Insects and Birds **9⁹⁵** 1203835
F Tropical Fish **10⁹⁵** 1209246

G Pattern Cardboard Frames

White cardboard frames, to be painted or decorated.
Assorted sizes and patterns. Pack of 24.

9⁹⁵ 1208784

H White Puzzles

White puzzles to be painted or decorated. Pack of 24.

14 x 20 cm
12 pieces **29⁹⁵** 2060309
21 x 28 cm
63 pieces **75⁹⁵** 2060333

I White puzzles

White cardboard puzzles, with frame, to be painted or decorated. In 4 pieces. Pack of 8.

8⁴⁵ 2060838



A Eye Stickers

Roll of 1000 – ø 14 mm eye stickers.

Black & White

7²⁰ 1201417

Assorted Colours

7²⁰ 1201466

B Paper Faces

Blank paper faces, in 8 realistic skin tones. Pack of 50. 16 cm long.

5⁹⁵ 1208800

C Decorate a mask

Neutral masks can be easily assembled, then painted and decorated. Set of 40.

7⁷⁰ 1204007

D Foam silhouettes

15 cm high. Assorted colours. Bag of 16.

2²⁵ 1202035

E Kids Silhouettes

Decorate your classroom with these unisex, paper silhouettes, ready to be painted with a large brush, fingerpainted, or personalized with fabric, buttons, yarn, and more (not included). White paper, with a glossy finish. With a teacher's guide.

Small
36 pieces 19 x 30 cm.

6²⁵ 1203629

Large
24 pieces 90 cm high.

19⁹⁵ 1204551

F Poseable People Stencil

Articulated stencil which pivots at the neck, waist, knees and ankles to recreate almost any pose. Proportioned to create Da Vinci's Vitruvian Man. Made of lightweight see-through and easy-to-clean material. 34 cm tall. With 1 craft idea guide.

8⁸⁰ 1207257

G People Shapes

Dress and decorate paper people shapes, in 8 realistic skin tones. Pack of 40. 26 cm long.

6¹⁰ 1208792

H Kid Puzzle Pieces

Each cardboard piece fits into the next, allowing for group projects. Pack of 24 units. 11 x 15 cm each.

9²⁰ 1203637

Posters



Giant Coloring Posters

On the ground, on the wall, the giant coloring posters will grab the attention of children of all ages. Little ones enjoy the large format on which they can draw to their heart's content while also developing their motor functions. Older children, on the other hand, pay attention to details, apply themselves and relax. The use of washable markers, wax crayons and coloured pencils is recommended.

A The Enchanted Forest

Look and find edition! Unicorns, dragons, princess, knight, pirates, witch and goblins... This giant colouring poster will make kids step into their enchanted world! 92 x 165 cm.

18⁹⁵ 1193606

B Little Monsters

A monster brushes his teeth, a unicorn-monster, one driving a tiny car and another who eats candy? Discover these small creatures on this charming colouring poster illustrated by Julie Cossette. 92 x 122 cm.

16⁹⁵ 1193614

C Extra large frames

These funny empty frames leave room children's creativity! One will draw either his face, favorite animal, family, friends ... according to his fantasies! 243 x 92 cm.

23⁹⁵ 1193622

D PlayMais Maxi® and Landscape Set

The PlayMais Landscape features 28 Landscape segments, each of which measures about 41.9 x 29.7 cm, or the size of two sheets of printer paper, as well as instruction ideas. When put together this creates a mural 7.9 meters length which pictures four distinct themes: ocean, plain, forest, and mountains. Each of these terrains also corresponds to a season and shows animals, plants, as well as people who are engaged in associated activities. Includes a box of 6300 PlayMais, 5 sponges, 5 knives, and 5 instruction booklets.

99⁹⁵ 2039725





Hint from B²

PlayMais®

PlayMais multicoloured, biodegradable pieces are made with corn and dyed with food colouring. Can be glued, cut, ripped or modeled. Just add a bit of water and the starch found in the corn (gluten-free) will make pieces stick to one another like glue.

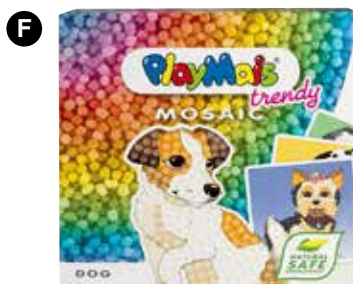

- 26 x [Aa] 2 x [Flower]
- 10 x [1] 2 x [Color palette]
- 3 x [Shapes] 2 x [Blank card]



PlayMais® Mosaic

Box of 2300 PlayMais mosaic pieces of various shapes and 6 model cards children complete.

A Zoo	14⁹⁵	2039733
B Ocean	14⁹⁵	2039741
C Friends	14⁹⁵	2039758
D Farm	14⁹⁵	2039766
E Unicorns	14⁹⁵	2039774

PlayMais® Mosaic Trendy

Includes 3000 Playmais in different shapes and colours, and 6 model sheets depicting each a dog, children complete using a colour-code (same as a paint by number)

F Dog	24⁹⁵	2077188
G Mandala	24⁹⁵	2077196

H PlayMais® Mosaic Eduline

Contains more than 12000 flakes of various shapes and colors. Includes 43 printable cards with thematic scenes, letters, numbers and shapes and 2 blank allowing children to create their own work.

38⁹⁵ 2177020

PlayMais® World

In addition to the Playmais pieces, includes 1 3D scene to build and decorate, and instructions to build wild animals: elephant, lion, zebra, giraffe, 1 felt square to moisten the pieces and 1 plastic knife.

I Safari	29⁹⁵	2077204
J Sea	29⁹⁵	2175578

K PlayMais® Fun to Learn

Includes 550 Playmais in different shapes and colours, 9 model sheets, 5 pre-cut 3D models, 1 knife and a felt square to dampen the flakes.

Colours and Forms **19⁹⁵** 2077212

L PlayMais® EDU

These group sets contain PlayMais, felt squares to moisten the PlayMais, knives and 1 ideas booklet.

1 500 pieces, 4 knives and 4 felt squares	34⁹⁵	2171130
6300 pieces, 6 knives and 6 felt squares	83⁹⁵	2171247

Creative Projects



A

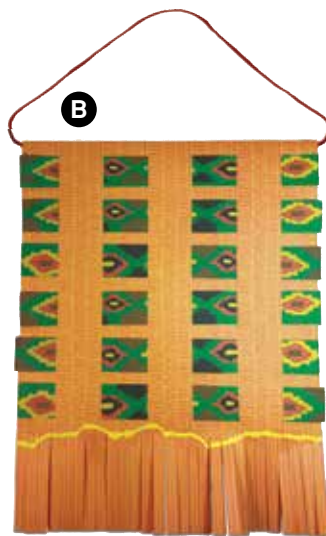

B

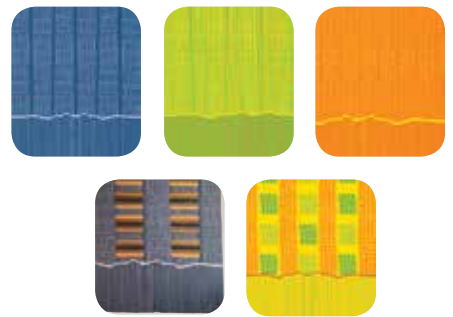

C



D



E



C

A Basket Bases

These basket bases make basket weaving easier. A variety of materials, such as yarn, paper strips or raffia, can be used to weave the baskets. Once complete, baskets can be decorated with drawings, cut-outs, stickers, etc. Baskets make ø 6 cm when complete. Includes 24 basket bases.

21⁹⁵ 1193515

B Kente Cloth Wall Hanging

Explore the rich story of Kente, traditionally woven in Ghana from silk and cotton. Introduce artistic styles to your students with beautiful cardstock mosaics. Half of the squares are printed in beautiful colours on both sides. The other half features a pointillist-inspired pattern in a wonderful range of mixed colours. Create simple geometric pattern or complex Georges Seurat-inspired works of art. Includes 24 sheets 21.5 x 28 cm) an idea guide.

19⁹⁵ 1142249

C Botanical Cuts

Features a great range of leaf and flower shapes cut from two-tone cards to create collages and 3D flowers. Set of 96 leaves 114 flowers and 1 craft idea guide.

10⁹⁵ 1209238

D Grafix Cling Film

Create decorations for diverse occasions with this opaque film that clings by static to smooth surfaces. It does not leave any residue, lose its shape, colour or cling, and is reusable. Just peel off and store for next time. Die cut, punch or cut out shapes and decorate with markers, paint pens and glitter glue. Packs of 18 sheets, 2 of each of the following colours: red, orange, yellow, green, blue, purple, clear, white and black. 9 x 12 in (22.8 x 30 cm).

19⁹⁵ 1131390

Shrink Film

Incredible plastic that shrinks to 50% its original size. Create unique plastic pieces to use in all your art & craft projects.

E 5.5 x 8.5 po. (12.7 x 20.3 cm)

Bright colours: red, orange, yellow, green, blue & purple. 4 sheets of each colour, for a total of 24 sheets.

8⁹⁵ 1131382

F 8.5 x 11 in (20.3 x 29.7 cm)

Clear, white, super sanded & black. 10 sheets of each colour, total 40 sheets.

19⁹⁵ 1131374

G Crafty Leaves

Features a variety of beautiful photo-realistic leaves printed on both sides of high quality craft paper. Great on posters or for seasonal crafts. Pack of 266 with a craft idea guide.

10⁹⁵ 1207042



F



G



A B



C

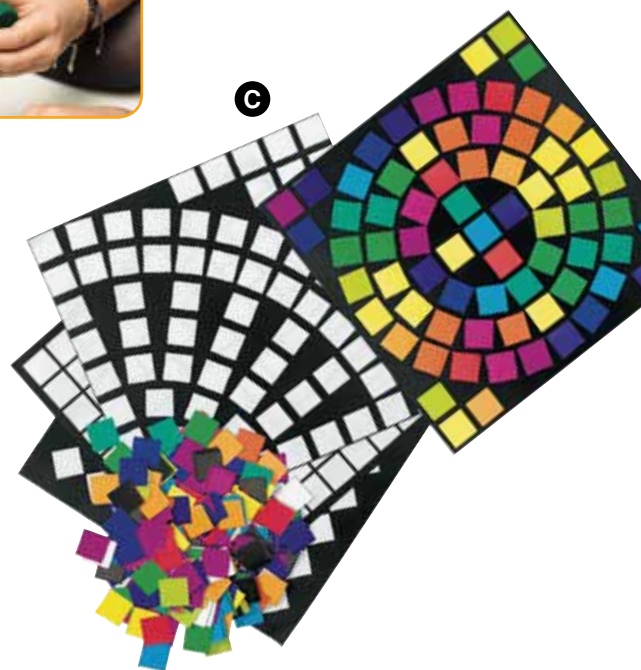

D



E



F



A Clip it

Creative and durable assembly game, made of recycled plastic, educates young and old alike on the environment. Children use small recycled plastic clips to connect bottle caps of different sizes (not included) and create an infinite variety of 2D and 3D models. Compatible with Lego bricks. Box of 450 clips of various colors, 300 2D clips and 150 3D clips. Allows a workshop with a group of 25 children. Start accumulating the bottle caps!

36⁹⁵ 2039683

B Mosaic Squares

Cardboard squares in assorted colours. For patterns and mosaics. Pack of 10,000 squares. 1 x 1 cm.

10⁹⁵ 1206903

C Mosaic Squares

Cardboard squares in 14 brilliant, assorted colours. Pack of 4000 squares. 2 x 2 cm.

10⁹⁵ 1203819

Mosaics

Assorted square glass and ceramic pieces multiple colours to create mosaics.

D 24-pack creative kit – Mosaic Coasters

24-pack creative kit – Mosaic Coasters
49⁹⁵ 1020502

E Glass Mosaics

In a storage container with lid. Assorted colours. 750 g. 19⁹⁵ 1020510

F 10 mm assorted mosaic container

In a storage container with lid. Assorted colours. 1 kg. 22⁹⁵ 1020528

20 mm Mosaics

In a storage container with lid. Assorted colours. 1 kg. 22⁹⁵ 1020536

Face Paint



Grim'tout Face Paint

Exclusive to B&B, Grim'tout make up products are of professional quality and paraben- and fragrance-free. Created for delicate skin, they can be applied on face and body. Colours can easily be mixed to create new shades or colour gradations. They must always be diluted with water and applied with a damp sponge or a brush. Simply remove with water. Meets CE cosmetic standards. Brush maintenance: clean without detergent after each session and avoid soaking in water. To preserve, put a bit of hair conditioner before storing.

Grim'tout Water – based face Paint Sticks

Easy to use for children, they simply turn the base and the stick comes out. Ready to use.

A 34 Make-Up Crayons Jar

Red, blue, yellow, green, black and white. **65⁹⁵** 1211754

B 6 Make-Up Crayons Card

Red, blue, yellow, green, black and white. **15⁹⁵** 1211747

C 6 Make-Up Crayons Card

Peach, pink, purple, light blue, dark green and brown. **15⁹⁵** 1212190

D 12 Make-Up Crayons Box

White, yellow, orange, red, pink, purple, light blue, dark blue, light green, dark green, brown and black. **29⁹⁵** 1212216

Grim'tout Make up Stencils

Sets of 4 sheets of adhesive, washable and reusable stencils!

- Cosmetic quality, very flexible
- Adapted to a child's face for each design, with cheeks or frontal motifs.
- Instructions for use, and illustrations included

E Set #1

Butterflies, pirates, fairytales and jungle **29⁹⁵** 1211804

F Set #2

Flowers, fairies, natives and magic **29⁹⁵** 1211812

G Grim'tout – face painting glitter gels

Sets of 3 glitter gels perfect to add a bright touch to the face painting! Apply it with a brush point. Can be preserved without drying for a long time. Professional quality. Paraben and fragrance free. For face and body. Created for delicate skin. Simply remove with water. Meets CE cosmetic standards. 3 x 25 ml.

Silver, golden and crystal

24⁹⁵ 1211762

Pink, mauve and turquoise

24⁹⁵ 1211770

H Clown noses

Pack of 12. Plastic. With an elastic thread. **15⁹⁵** 1204270

I Grim'tout – Clown White

White water-based face make-up with a creamy texture and very opaque. Allows making a superb makeup. 50 ml.

14⁹⁵ 1211861

J Grim'tout Carnival Kit

9 colour palette: among the most frequently used for kid's makeup. Also includes a sponge, a brush and a 16 page booklet with models. The book features more than 20 models and gives instructions for using the products. Allows to make up about 60 to 80 children depending on the model. 9 x 3 ml

31⁹⁵ 1211655

K Grim'tout Jumbo Kit

This kit has been especially created for groups. It contains 8 essential water-based colours in large contents, and a brush safely placed in its dedicated area to avoid falling on the floor. Allows to paint more around 500 faces! 8 x 15 ml.

78⁹⁵ 1211663

L Grim'tout 12 colours Basic party palette

12 basic colours kit, including 2 metallic colours (golden and silver) and a brush. Sturdy hinged box. The book features more than 20 models and gives instructions for using the products. Allows to make up about 60 to 80 children depending on the model. Total of 50 ml.

34⁹⁵ 1211671

M Grim'tout whole in one Mega Fiesta Box

Box of 6 colour palette, 1 glitter gel tube, 2 face painting stencils with more than 40 patterns, 4 step by step model sheets, a brush and a sponge. The book features more than 20 models and gives instructions for using the products. Allows to make up about 60 to 80 children depending on the model. Each sheet shows a step by step model and gives instructions for using the products.

59⁹⁵ 1211689

N Grim'tout Accessories Kit

Face painting accessories kit includes 4 round foam sponges, 5 brushes – 3 flat, 2 round – and an applicator. Quality synthetic bristles that enable fine and precise rendering. The transparent case closes with a zipper closure.

Maintenance of brushes: clean without detergent after each session and avoid soaking in water. To preserve, put a bit of little hair conditioner before storing.

13⁹⁵ 1211853

O Grim'tout face paint stencil brushes

Set of 2 quality brushes for makeup stencils. Made of synthetic bristles. Allow to apply make-up evenly and quickly.

- Quality pony hair
- Maintenance: clean without detergent after each session and avoid soaking in water. To preserve, put a bit of little hair conditioner before storing.

9¹⁵ 1211838

P Grim'tout face painting brushes

Set of 10 long and fine brushes for fine lines and details. Quality synthetic bristles that enable fine and precise rendering. Maintenance: clean without detergent after each session and avoid soaking in water. To preserve, put a bit of little hair conditioner before storing.

13⁹⁵ 1211820

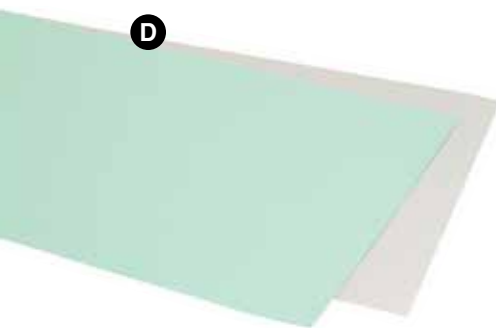
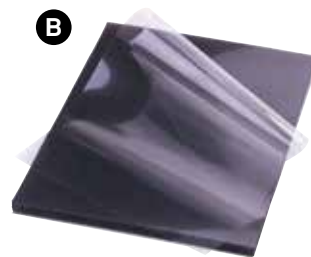

A Livres de la méthode Prouche

Learn how to create comic strips using the organization of basic geometric shapes in a quick and effective composition. Providing an opportunity to outline and develop the desired idea, for a quickly-achieved, astonishing final result, whether to create a comic strip or draw a sofa, a car, a fir tree, a dog or a character. **In French.**

- J'utilise des trucs pour ma B.D. **14⁹⁵** 2200798
- Je dessine des centaines d'autos **14⁹⁵** 2200814
- Je dessine mille et un visages **14⁹⁵** 2200822
- Je dessine des personnages B.D. **14⁹⁵** 2200830
- Je dessine des personnages bizarres et monstrueux **14⁹⁵** 2200848
- Je m'amuse à dessiner des chiens **14⁹⁵** 2200855

B Overhead transparencies

Box of 100. 21.6 x 28 cm. **22⁹⁵** 3132800

C EZ Tracer Projector

Enlarge drawings, photos, patterns up to 10 times! Simply place the projector on the chosen work. What a simple way to create murals, posters, paintings and more! Optical glass lens. Requires one 23-watt fluorescent bulb (not included, see 2320216). **69⁹⁵** 2320208

Replacement Bulb

23-watt fluorescent bulb for EZ Tracer Projector 2320208 (sold separately). Not shown. **14⁹⁵** 2320216

D Acetates for Desk Pad – Clear

48.3 x 61 cm **2⁵⁵** 3131414

E Junior Geoland Junior – Pattern Set

The child colours the patterned sheets and then explores notions of symmetry and reflection by placing the mirrors at different angles in the base plate. Helps develop observation, learn about perspective, the play of colors and shapes. Includes 48 colouring sheets with 12 different drawings, 2 rectangular mirrors and a baseplate. **26⁹⁵** 2016640

F Geoland coloring book 36 pcs

Set of 36 coloring hemispheres; patterned drawings to explore the notions of symmetry and reflection. (Board and mirrors sold separately) **14⁹⁵** 2039964

G Flexible Mirrors

Ideal for use by children, these mirrors are flexible, unbreakable and can be cut into different shapes, with regular scissors, for endless uses. Demonstrate concave and convex properties, tape them together for multiple reflections, etc. Also great for "All About Me" language activities. Set of (3) 30 x 20 cm, one-sided PC mirrors, 0.55 mm thick, with round corners. **17⁹⁵** 2088425

String and Wool



A Coloured String

100 m rolls.

Black	12⁹⁵	1150135
Gold	12⁹⁵	1150085
Rainbow	13⁹⁵	1150077
Silver	12⁹⁵	1150127

B Plastic Lace

Sturdy, plastic, flat lace. 2 mm. 91.4 m roll.

Black	4²⁰	1510064
Blue	4²⁰	1510056
Green	4²⁰	1510049
Orange	4²⁰	1510023
Red	4²⁰	1510015
White	4²⁰	1510007
Yellow	4²⁰	1510031

C Embroidery thread

Set of 24 skeins of embroidery thread. 100% cotton. 8 colours. 8 meters each.

6⁹⁵ 1121763

D Weaving Loops

Assorted colours. 142 g bag.

9⁹⁵ 1301365

E Weaving Loom

Small, all-metal loom, for looping with included hook. 18 x 18 cm.

27⁹⁵ 1304302

F Acrylic Cord

Pack of 10 assorted colours. 15 m.

9⁷⁵ 1150002

G Butcher's Cord

White string, 12 ply. 454 g.

15⁹⁵ 1150218

H Hemp String

Roll of natural hemp string. 2 strands. 380 feet (115,8 m).

5⁶⁰ 1121771

I White String

20 ply. 1.13 kg.

39⁹⁵ 1150200

J String

4 ply. 1.13 kg.

White	32⁹⁵	1153014
Red	73⁹⁵	1153030

K White String

85 g

4⁵⁵ 1153006

**A Knitting Needles**

Pack of 2 bamboo knitting needles.

4 mm	7⁵⁵	1209360
6 mm	8¹⁰	1209337
7 mm	9⁹⁵	1209345

B Crochet Hook

Wool crochet hook, with flat section. 3.5 mm

2³⁰ 1209378**C Plastic Weaving Needles**

Colourful plastic needles. Safe tips. 15 cm long. Pack of 12

4⁹⁵ 1193523**D Canadiana Yarn**

For knitting and decorating, 100% acrylic, machine washable and dryable. 100 g (4 ply).

Black	6⁰⁵	1300185
Blue	6⁰⁵	1300151
Orange	6⁰⁵	1300193
Purple	6⁰⁵	1300201
Red	6⁰⁵	1300219

White

6⁰⁵ 1300144

Yellow

6⁰⁵ 1300177**E Québécoise 6-Ply Wool**

100 g skeins. 100% wool.

Black	5³⁵	1303965
Irish green	5³⁵	1304021
Medium brown	5³⁵	1303932
Orange	5³⁵	1303981
Pink	5³⁵	1303999
Red	5³⁵	1304005
Royal blue	5³⁵	1303924
Turquoise	5³⁵	1304013
White	5³⁵	1303916
Yellow	5³⁵	1303940

Knitting Looms

Large knitting looms, to make hats or scarves. Each loom comes with a hook and instructions.

F Long rectangular loom 38 cm	9⁷⁵	1209188
G Large round loom 20 cm	9⁸⁰	1209170

H Wikki Stix

Simply press these endlessly reusable, coloured wax strings on paper to draw pictures, make borders to help children colour in, reproduce raised shapes, numbers and letters, master the notion of quantity, and much more. Can also be joined to create 3D structures. Do not dry or crumble, and can be easily cut with scissors. Ideal for children with special needs.

Primary ColoursSet of 48 – 20-cm strings, in 6 colours. **9²⁰** 1150093**Neon Colours**

Set of 48 – 20-cm strings, in 6 assorted neon colours.

9²⁰ 1150101**Group Set**

Set of 468 – 15-cm strings, in 13 colours.

Includes a 12-page activity guide. **45⁹⁵** 1150119**Super Wikki**

Set of (48) 91 4 cm long strings, in 6 neon colours.

25⁹⁵ 1150168

Beads and Jewellery



A



B BB



C BB

D



E BB



F



G



H

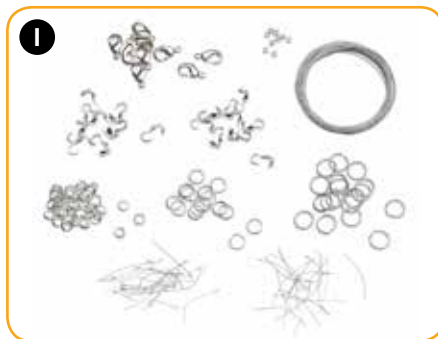

I



J



K

A Case of Opaque Beads

Opaque, ø 9 mm plastic pony beads, in 18 assorted colours. In a see-through plastic case with compartments.

Rainbow Colours

2300 beads. **32⁹⁵** 2310001

Extravaganza

3600 beads. **37⁹⁵** 2310316

B Glass Seed Beads

Glass seed beads. Used as spacers or for making jewellery. In a plastic box with compartments. 12 colours. 1200 g.

26⁹⁵ 1192681

C Wood and Bones Beads Assortment

Wood and bone beads assortment in various shades: natural, beige and brown. 100 g bag.

5⁹⁵ 1192616

D Empty Plastic Box with 12 Sections

12-compartment plastic box, perfect for organizing and storing all very small objects. 27 x 18 x 4 cm.

7⁹⁵ 1192699

E Large Glass Beads

Large glass beads in various shapes and colours for necklaces, bracelets, etc. In a plastic box with compartments. 900 g.

26⁹⁵ 1192673

F Wood beads

Wood beads assortment in various shapes and shades: natural, beige, brown. 250 g bag.

5⁴⁰ 1193143

G Glass beads

Glass beads assortment in various shapes and frosted colours. 400 g bag.

5⁴⁰ 1193127

H Bone Beads

Bone beads assortment in various shapes and colours. 250 g bag.

5⁴⁰ 1193135

I Bracelet Making Accessories

Various silver plated metal accessories for making bracelets.

13⁹⁵ 1192756

J Accessories for Making Earrings

Various silver plated metal accessories for making earrings.

12⁹⁵ 1192764

K Accessories for Making Necklaces

Various silver plated metal accessories for making necklaces.

11⁹⁵ 1192772



A Silver Plated Chain
Silver plated metal chain for jewellery making.

Silver Plated Chain
3 mm x 5 m **5⁹⁵** 1192707

Cable chain
3.5 mm x 5 m **6⁹⁵** 1192715

Curb Chain
2 mm x 5 m **4⁹⁵** 1192723

Cable chain
4 mm x 5 m **9³⁰** 1192731

B Silver Metal Wire
Silver metal wire for jewellery making.
0.45 m x 10 m. **1⁹⁵** 1192665

C Eye Pins & Head Pins
Eye pins and head pins for jewellery making.
50 g bag. **4⁹⁵** 1192749

D Nylon Thread
Single thread. 0.5 mm x 50 m. **2⁹⁵** 1192608

E Jewellery-making Accessories
All metal. Pack of 100.
Rings 25 mm **4⁷⁰** 1201482

F Clear Plastic Cord
Very sturdy, extensible plastic cord, ideal for jewellery-making. ø 1 mm. 100 m roll. **5⁴⁵** 1150051

Leather String
Leather string for jewellery making.
1 mm x 5 m.

G Natural **3²⁵** 1192624

H Black **3²⁵** 1192632

I Black Satin String
Black satin string for jewellery making.
1 mm x 5 m. **1⁹⁵** 1192640

J Black Cotton String
Black cotton string for jewellery making.
0.5 mm x 10 m. **3²⁵** 1192657

K Jewellery String
Set of 10 – 30 m rolls each. In assorted colours ideal to create jewellery. **17⁹⁵** 1150143

L Brooch Backs
Pack of 25 brooch backs. 28 mm x 7 mm.
With adhesive back. **14⁹⁵** 1210160

M Jewellery Pliers
Set of 3 jewellery pliers.
Very useful, ergonomic handles. **25⁹⁵** 1190032

Projects



A Birdhouses to Decorate

Set of 36 accessories. Jute cord for hanging. 3 different moels. 15 cm high.
59⁹⁵ 1123066

B Wooden Picture Frame

Wooden picture frame, to be decorated creatively. For 4" x 6" photo.
2⁹⁰ 1121870

C Yoyos to be Painted

Set of 10 wooden yoyos to be painted.
19⁹⁵ 2111086

Hama Iron-On Beads and Accessories

Includes everything necessary to design beautiful creations with iron-on beads.

D Boards

Set of 4 boards 14 x 14 cm and instructions.
10⁹⁵ 1207026

E Iron-On Beads – Paper

4 sheets 42.3 x 18.6 cm each.
4⁹⁵ 1350859

F 6000 Midi Beads

14⁹⁵ 2310530

G Hama Beads Group Pack

This group pack is composed of 21000 assorted beads, 21 adorable model boards, one inspiration book, ironing paper and instructions.
125⁹⁵ 2090256

Hand Puppets to Decorate

H Felt
 Set of 10 felt hand puppets to decorate. 26 x 27 cm.
9⁴⁰ 2232163

I Cotton

Set of 6 cotton hand puppets to decorate. 13 x 20 cm.
7⁴⁰ 2232171

J Jar with Lid

Glass jar with lid. 250 mL.
1³⁵ 1140722



A Assorted Masks Set

Set of 10 masks in 5 different models. Made of papier maché.
19⁹⁵ 1192590

B White Masks to Decorate

Easy-to-decorate, white papier-mache masks with an elastic band. Pack of 10.
15⁹⁵ 1192582

C Mardi Gras Masks

White masks made of papier maché, with elastic. Can be painted or decorated. 10-pack.
15⁹⁵ 1192574

D Plastic Christmas Balls to Decorate

Box of 12 Christmas balls for self decoration, made of clear plastic. Balls of ø 8 cm.
14⁹⁵ 1123041

E Snowflakes to decorate

Set of 8 polyfoam snowflakes one can decorate. What a fun winter activity! 7.6 x 1.2 cm each.
1⁵⁰ 1123058

LABORATOIRE *créatif*

BB.ca

Brault & Bouthillier
Éducation



When art and *technology meet!*

In a Makerspace, we can create projects with simple sheets of paper or delve into high-tech, everything is possible! We mainly develop the art of learning.

The Makerspace is a place where students and teachers create projects where they find their own solutions. It is a place for sharing, exchanging, trying, making mistakes, starting over and succeeding...together!

An array of tools and materials are at your disposal to unleash creative minds.

Do you know STEAM?

Science + Technology + Engineering + Art + Math

From paper to wooden sticks, crayons to 3D printers, when an idea is launched or a project starts taking shape, the trial and error process brings the Makerspace to life.

Meeting place for a community of learners, it's not just about sharing tools, it's mainly about sharing knowledge and experiences.

Resources for the Makerspace can be found in the **creative thinking (robotics), science and technology** sections, as well as the **art and creative leisure** section of this catalog.



ULIO 3D Printer

ULIO is a printable 3D printer. This user-friendly kit allows access to online videos to learn how to draw, print and assemble ULIO, as well as the ability to download all print files in STL format. Important notes: To print ULIO, you need access to an existing 3D printer that can print an 8 x 8 inch object (ULIO can be adjusted to 8 x 6.2 x 8 inches). Requires adult help and supervision

697⁹⁵ 2089233



Playmat – 4-in-1 Workshop

This safe and inspiring wood-crafting workshop was developed for the young Do-It-Yourselfers. The kit includes all the necessary parts for building up to 4 different, real-working machines made of easy-to-assemble, well-designed component pieces: a drill press, wood lathe (for softwood up to ø 30 mm), jigsaw (the world's only child-friendly jigsaw, for plywood up to 6 mm thick) and sander (can also sharpen tools). Includes a 12V safety adaptor, detailed instructions, plans and suggestions, and wood for turning and sawing, to start right away. Visit <http://www.thecooltool.com/> for a video tutorial on how to assemble your workshop.

146⁹⁵ 2099380



Worbla Thermoplastic

This thermoplastic modelling material can be shaped by hand without special safety equipment. It can take complex curves without requiring vacuum forming, and is self-adhesive when heated: no glue is required to join pieces. Shape the plastic however you want simply with hot air, water or steam. There's no waste, leftovers can be conditioned and totally re-blended and moulded to become just like putty. Many artists use Worbla instead of clay to create near-indestructible pieces. Non-toxic and skin safe. One leaf of 100 cm x 150 cm.

115⁹⁵ 1212877



A Pilot Fineliner Felt Pens

Price per unit, sold in 12 unit boxes.

Black	1⁵⁵	3294303
Blue	1⁵⁵	3294279
Green	1⁵⁵	3294337
Red	1⁵⁵	3294329

B V Sign Felt Pen

Wide stroke, ideal for drawing.

3²⁰ 3295177

C Hi-tec V5 Pilot Ballpoint Pens

Ultra-fine point. Price per unit, sold in 12 unit boxes.

Black	2⁵⁰	3351616
Blue	2⁵⁰	3351624
Green	2⁵⁰	3351640
Pink	2⁵⁰	3352036

Purple	2⁵⁰	3352044
Red	2⁵⁰	3351632
Turquoise	2⁵⁰	3352028

D Frixion™ Roller Ball Pens

Roller ball 0.7 mm. Erasable with rubber tip. Ultra-fine point. Price per unit, sold in 12 unit boxes.

Black	2⁶⁵	3350758
Blue	2⁶⁵	3350675
Green	2⁶⁵	3350766
Red	2⁶⁵	3350774

E Fine Line Black Drawing Pen

Pigmented ink pens great for all manga and anime style comic artwork. They are permanent when dry. Available in black ink only and seven point sizes. Sold individually, minimum purchase 12 units.

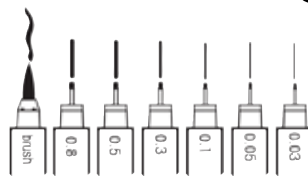

0.03 mm	2³⁰	3299575
0.05 mm	2³⁰	3299583
0.1 mm	2³⁰	3299591
0.3 mm	2³⁰	3299609
0.5 mm	2³⁰	3299617
0.8 mm	2³⁰	3299625
Brush	2³⁰	3299633

F Pilot Felt Pens

Felt pens for stippled drawing. Black pigment ink.

One tip 0.25 mm	2⁹⁵	3280153
One tip 0.35 mm	2⁹⁵	3280161
One tip 0.4 mm	2⁹⁵	3293750
One tip 0.5 mm	2⁹⁵	3280179
One tip 0.8 mm	2⁹⁵	3280187
Pouch of 5 tips	13⁹⁵	3293784



A Slider Memo XB pen

Ballpoint pen with Viscoglide® technology. Writes extra wide lines. The wear-resistant stainless steel tip guarantees clean, stain-free writing and the use of all ink. It dries quickly – also on smooth paper – and does not fade, even when passing the highlighter. Indelible according to ISO 12757-2. Rubberized ergonomic body for safe, relaxed and fatigue-free grip. The reversible hood has a stable metal clip. CO₂ neutral production.

Black	3³⁵	3151982
Blue	3³⁵	3151958
Green	3³⁵	3151990
Orange	3³⁵	3152006
Pink	3³⁵	3152022
Purple	3³⁵	3152014
Red	3³⁵	3151966

B Slider Edge Pens XB

Viscoglide® technology ballpoint pen ensures smooth, lightweight writing. Wear-resistant stainless steel tip that writes cleanly and stain-free and guarantees the use of all ink. Quick drying ink – also on smooth paper – and non-fading, even covered with highlighter. Perfect for drawing or painting because the ink does not flow even on absorbing paper. The triangular rubberized body allows ergonomic grip. Does not roll. Reversible cap. Fine tip. CO₂ neutral manufacturing.

Black	2⁵⁵	3152071
Blue	2⁵⁵	3152287
Green	2⁵⁵	3152295
Red	2⁵⁵	3152105

C Stylus Roller One Business

The ultra-soft tip provides an excellent writing experience. Its innovative system ensures good ink flow from start to finish. Can remain open for 2 or 3 days without drying. High quality metal clip and ergonomic rubber grip. Lines are around 0.6 mm. Permanent.

Black	3⁵⁵	3152550
Blue	3⁵⁵	3152576
Green	3⁵⁵	3152584
Purple	3⁵⁵	3152592
Red	3⁵⁵	3152568

D Hard copy felt pens

Extra-fine tip. Black. Box of 12.
18⁹⁵ 3297694

E BIC MS11 Ballpoint Pens

Medium point. Box of 12.
Black **3⁵⁵** 3350196
Blue **3⁵⁵** 3350188
Red **3⁵⁵** 3350204

F Paper Mate Ballpoint Pens

Box of 12.
Medium tip
Black **2⁸⁰** 3350725
Blue **2⁸⁰** 3350717
Red **2⁸⁰** 3350733

G Pilot V-ball Grip Ballpoint Pens

Ultra-fine point. Price per unit, sold in 12 unit boxes.
Black **2⁵⁵** 3352457
Blue **2⁵⁵** 3352465
Red **2⁵⁵** 3352473

H Paper Mate Ink Joy 300 ballpoint pen

Retractable. Box of 12.
Black **6⁸⁵** 3352721
Blue **6⁸⁵** 3352713
Red **6⁸⁵** 3352739

Pencils and Pencil Grips



A Mirado Pencils

Superior quality lead pencils, with eraser tip. Available in 2 hardnesses. Box of 12.

HB **2⁹⁵** 3150810

B HB Triangular Pencils

Box of 12.

3⁶⁰ 3140480

C Staedtler Norica Pencils

Pencils with latex-free, white vinyl eraser. Box of 12.

2H **3⁴⁰** 1180249

HB **3⁴⁰** 1180256

D Ticonderoga Graphite Pencils

Box of 12.

4⁶⁰ 3150745

E Staedtler Jumbo Triangular Pencils

Thick diameter for easy grip, with eraser. Perfect for learning. HB. Box of 12

8⁷⁵ 1180397

F Primary Print Pencils

These pencils have a large diameter for a good grip by small hands. Both are non-toxic. Box of 12.

Red #1
ø 13/32" **6⁹⁰** 3150935

Blue #2
ø 11/32" **6⁹⁰** 3151537

G Large Triangular HB Pencils

Per unit

0⁹⁵ 3150042

H Correction Pencils

Red lead. Box of 12.

6⁹⁵ 3150380

I HB Pencils

Hexagonal shape, with HB lead and eraser tip. Pack of 12.

3²⁰ 3150778

J Pentel Mechanical Pencil

Ergonomic mechanical pencils. The sliding sleeve technology lets you keep writing even when the lead breaks. Easy to hold and non-rolling triangular shape.

0.5 mm **0⁹⁹** 3151925

0.7 mm **0⁹⁹** 3151933

K Graphite Leads

Graphite leads with a porous ceramic cell structure and a high polymer level. Dark and smooth lines. Strong and smooth to use. 40 leads per tube.

0.5 mm **3⁷⁰** 3151313

0.7 mm **3⁷⁰** 3151511

Pencil grips

These pencil grips incorporate special features that encourage proper pencil grasp for better comfort and control. Can be used with the right or left hand. Rubber.

Pack of 12.

L Pencil grips – Rounded **33⁹⁵** 3150166

M Pencil grips – Jumbo Grip **54⁹⁵** 3150174

N Pencil grips – Triangle Grip **5⁹⁵** 3150182

O Pencil grips – Crossover Grip **34⁹⁵** 3150208

P Writing C.L.A.W. Medium **33⁹⁵** 3150216

Pencil Sharpeners and Erasers



- A Boston L Pencil Sharpener**
For regular size pencils.
22⁹⁵ 3020062
- B Boston KS Pencil Sharpener**
For 8 different sizes of pencils.
Stops automatically.
17⁹⁵ 3020070
- C Pocket-Size Pencil Sharpeners**
Metal, pocket model, for standard size pencils. Box of 10.
3⁹⁵ 3020153
- D Pencil Sharpener**
Metal, double-hole model.
0⁹⁵ 1182682
- E Scholar Pencil Sharpener**
German-made, high-quality blade.
2¹⁵ 3020203

- F Round Staedtler Pencil Sharpener**
Plastic pencil sharpener, with shavings receptacle. Single hole.
3⁹⁵ 3327723
- G Pencil Sharpener**
Pocket model, for standard size and jumbo pencils. With shavings receptacle.
1³⁵ 3020294
- H Double-Hole Staedtler Tub Sharpener**
Pencil sharpener with shavings receptacle, for standard size and jumbo pencils.
4⁹⁵ 3320009
- I X-Acto Electric Pencil Sharpener**
Heavy-duty model, for standard size pencils. Stops automatically.
57⁹⁵ 3020682

- J X-Acto School Pro Electric Pencil Sharpener**
Heavy-duty, quiet model, especially designed for intensive use. Stops automatically. With 6 various-size openings and a very large shavings receptacle.
68⁹⁵ 3020690
- K Staedtler Cleaning Eraser**
51 x 25 x 22 mm.
1³⁰ 1180173
- L Staedtler Erasing Shield**
Flexible, stainless steel. 9.5 x 6.4 cm.
2²⁵ 3320074
- M Pink Pearl Erasers**
Pink. For pencils.
63 x 20 x 7 mm **0⁴⁸** 3180114
45 x 17 x 7 mm **0⁴¹** 3180106
- N Pink Carnation Eraser**
Pink. For pencils. **0³¹** 3180585

- O Selectum Eraser**
White, economical eraser.
0⁴⁶ 3180643
- P Staedtler Erasers**
Plastic, soft, latex-free.
Economical # 526-30
Single unit **0⁸³** 3180171
White eraser, Mars-Plastic # 526-50
Single Unit **1²⁵** 3324019
- Staedtler Eraser Holder**
Eraser holder with a clickable pushing system.
- Q Eraser Holder**
2³⁰ 3180221
- R Refill Eraser**
White PVC-free Staedtler eraser stick. Pack of 2. **0⁹⁷** 3180239

Highlighters and Correction



A Sharpie Clearview Highlighters

Permanent marker featuring a unique, transparent tip that allows you to highlight neatly and evenly all the way across the page. Ideal for precise highlighting to create clear, legible notes. Versatile blade-style tip draws thick lines for highlighting or clear lines for underlining. AP Certified.

Pink	2⁵⁰	3280203
Yellow	2⁵⁰	3280195

B Staedtler Highlighter

Highlighters with chisel tip. Inkjet safe.

Blue	2⁰⁵	3190642
Orange	2⁰⁵	3190527

C Accent Highlighters

Box of 12.

Green	9⁹⁵	3352747
Orange	9⁹⁵	3352762
Pink	9⁹⁵	3352754
Yellow	9⁹⁵	3352770

D Sharpie Fluorescent Liquid Highlighters

Per unit.

Blue	1⁹⁰	3299203
Green	1⁹⁰	3299245
Orange	1⁹⁰	3299229
Pink	1⁹⁰	3299237
Yellow	1⁹⁰	3299211

E Gel Highlighters

Yellow, orange and pink

6⁸⁵	3290848
-----------------------	---------

F Liquid Paper Correction Fluid

Foam applicator. 22 mL.

2¹⁵	3120094
-----------------------	---------

G EZ Correct Tape

12 m

3⁵⁵	3120177
-----------------------	---------

H Pritt Correcting Tape

Single line

4⁵⁰	3392222
-----------------------	---------

I Corrector pen

Fast drying multipurpose correction pen. Its fine tip and 4 mm metal nib make it unrivaled for precision artistic work on all support.

5⁹⁵	3352846
-----------------------	---------



A Sharpie Permanent Markers

Quick-drying, permanent ink for all surfaces. Resistant and long-lasting tip. Price per unit, sold in 12 unit boxes.

	A1	A2	A3	A4	A5
	Liquid Tip	Chisel point	Fine tip 1.0 mm	Wide tip 1.5 mm	Ultra fine tip 0.3 mm
Black	3290798	3291812	3297116	3290970	3290889
Blue		3291804	3297082	3290962	
Green			3297157		
Red		3291820	3297140	3290988	
	1⁸⁵	1⁵⁰	1⁵⁰	2¹⁵	1⁵⁰

B Liqui-Mark Permanent Markers

Chisel point. Regular size.

8 colours **7⁸⁵** 3297710

C Markette Markers

Price per unit, sold in boxes of 12.

Black

Chisel point	Black	2²⁰	3292752
Conical tip	Black	2²⁰	3292679

D Bic Mark it Permanent Marker

Fine tip. Black. Price per unit, sold in 12 unit boxes.

0⁹² 3290350

E Blaisdell Grease Pencils

Write on glass, plastic and any other similar smooth surface. Black. Box of 12.

9⁹⁵ 3150562

F Staedtler Permanent Special Markers

Special markers for all surfaces, including glass. Black. Price per unit, sold in 10 unit boxes.

0.4 mm	3³⁵	3290277
0.6 mm	3³⁵	3290251
1.0 mm	3³⁵	3290269



Whiteboard Markers and Accessories



A Expo 2 Dry-erase Markers

Low odor. Non-toxic.

Chisel point

Black	1⁸⁵	3295292
4 colours	7²⁰	3295334
8 colours	13⁹⁵	3295342

Expo Dry-erase Markers

Magnetic holder. Made with 90% recycled materials.

B Holder and markers

12⁹⁵ 3290814

C 4 various colours

10⁹⁵ 3153418

D Expo 2-In-1 dry-erase Markers

The chiseled tip traces 3 types of lines: Large, medium and fine. The low odour ink is ideal for classrooms. Perfect for whiteboards, glass and other non-porous surfaces.

10⁹⁵ 3153434

E Expo Neon Dry-erase Markers

Expo Neon Dry-erase Markers

5 colours **10⁹⁵** 3291101

F Whiteboard Eraser Brush

3⁶⁵ 3298791

G Dry-erase Crayons

Dry-erase crayons, with erasing mitt included. Washable on most fabrics. Box of 8 colours.

For whiteboards **3⁹⁰** 1170943

H Dry-Erase Markers Fine Line

Set of 4 dry-erase markers, fine line, bullet tip (red, blue, green and black).

5⁹⁵ 1312180

I Crayola Whiteboard Dry-erase Markers

Chisel tip, low odor, non toxic.

12 colours **11⁹⁵** 1312198

J Crayola Whiteboard Dry-erase Markers

Chisel tip. Solid colours. 12 marker sleeve, of the same colour. Black

13⁹⁵ 3294097

K Pentel Dry-erase Markers

Conical fine point. Low odor. Non-toxic. Per unit.

Black	2³⁰	3352390
Blue	2³⁰	3352374
Green	2³⁰	3352408
Red	2³⁰	3352382



A Staedtler Acetate Markers

Price per unit, sold in 10 unit boxes.

Fine tip Black

318 Permanent	2³⁰	3291036
316 Soluble	2³⁰	3295276

Medium tip Black

317 Permanent	2³⁰	3293891
315 Soluble	2³⁰	3294089

B Staedtler Permanent Markers

Fine or medium point.

	4 colours	8 colours
Fine tips	3295565	3295706
Medium tips	3290715	3290749
	9²⁵	17⁹⁵

C Staedtler Acetate Markers

Excellent for tracing on acetates, slides and other similar materials, as well as on Amerix maps. Available in packs of 4, 6 or 8 colours. Water-soluble (washable). Fine or medium point.

Medium tip, 4 colours	9²⁵	3290376
Medium tip, 6 colours	13⁹⁵	3290418
Medium tip, 8 colours	17⁹⁵	3290426
Fine tip, 6 colours	13⁹⁵	3294808
Fine tip, 8 colours	17⁹⁵	3294816
Fine tip, 4 colours	9²⁵	3295458

D Graftix Cling Film

Create decorations for diverse occasions with this opaque film that clings by static to smooth surfaces. It does not leave any residue, lose its shape, colour or cling, and is reusable. Just peel off and store for next time. Die cut, punch or cut out shapes and decorate with markers, paint pens and glitter glue. Packs of 18 sheets, 2 of each of the following colours: red, orange, yellow, green, blue, purple, clear, white and black. 9 x 12 in (22.8 x 30 cm).

19⁹⁵ 1131390

E Craft plastic

This craft plastic offers crystal clear surface for all your creative projects: scrapbook pages, albums, frames, ornaments, and more. Cuts easily with scissors, craft knives and many die cutting machines. Draw on it with permanent markers, rubber stamps, glitter, beads, ribbons. Comes protected with a peel away liner. Heavy weight (.020" thick). Acid free. 9 x 12 po (22.8 x 30 cm). 24 sheets pack.

74⁹⁵ 1131424

F Overhead transparencies

Box of 100. 21.6 x 28 cm.

22⁹⁵ 3132800

Chalk



A Sanigene Chalk

Dustless. Box of 144.

White	10⁹⁵	3010642
Yellow	10⁹⁵	3011152
Assorted colours	13⁹⁵	3011178

B Colourex Chalk

Dustless. Assorted colours. Box of 12.

1⁴⁰ 3010683

C Swan White Chalk

Semi-soft. Box of 12.

1⁹⁵ 3010675

Mungyo chalk

Dustless, coated with a plastic film.

Box of 100.

White	5⁵⁵	3010667
Yellow	7³⁰	3010691
Assorted colours	8⁶⁵	3010659

Mungyo Chalk

Dustless, coated with a plastic film.

Box of 12.

E Assorted colours **0⁹⁸** 3010378

F White **0⁹⁶** 3010394

G Sidewalk Chalk

Assorted colours. Bucket of 10.

1⁴⁵ 3010535

H Chalk Holders – Metal

All-metal. Sturdy and durable.

6⁶⁰ 3011897

Bistro Liquid Chalk Markers

Multi-purpose chalk, opaque liquid ink marker that can be used on chalkboards, light boards, plastic and glass. Its pigmented ink is water-based and erasable with a damp cloth.

I Classic colours

Black, blue, red, white. 6 mm **15⁹⁵** 3299559

J Neon colours

Blue, green, red, yellow. 6 mm. **15⁹⁵** 3299567

White

Not shown. 6 mm **4⁶⁵** 3299419

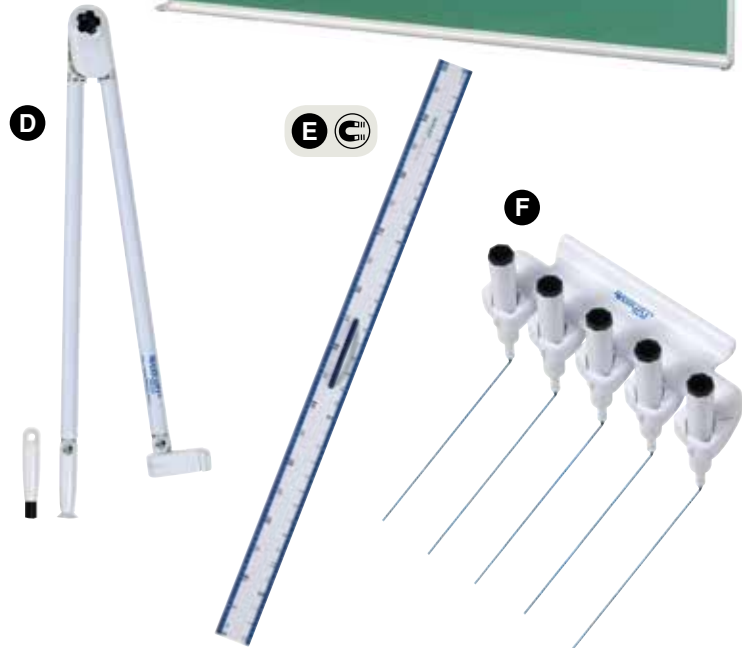
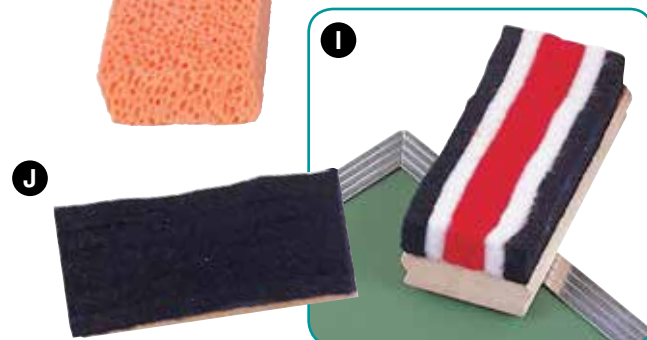
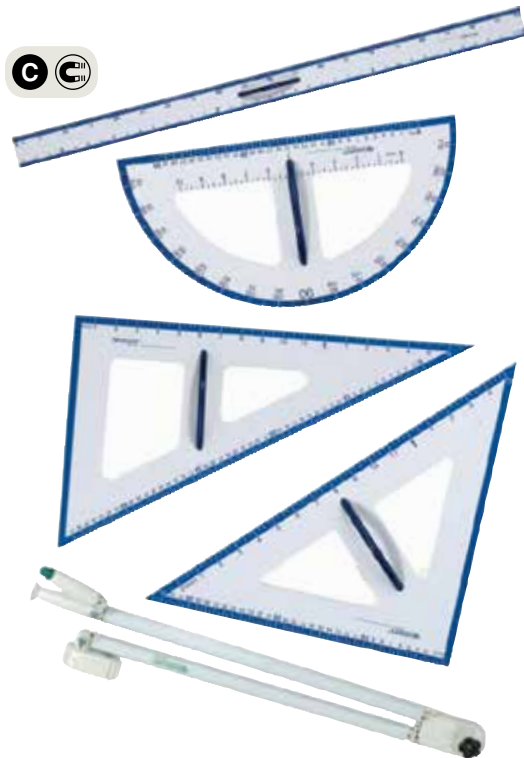
**A Duolox Masonite Boards**

Light and economical. Features aluminium frame with chalk rail. Green.

24" x 36"	34⁹⁵	3360336
36" x 48"	56⁹⁵	3360344

B Series 2000 Green Lauzonite Chalkboards

Industrial quality, sturdy boards. Hook rail, chalk rail with protective end caps. High performance surface. Lauzonite consists of a steel sheet and 4 layers of resin, fired at a high temperature to produce a heavy-duty, easy-to-clean surface. Chalk strokes are full and surface reflexion is low, ensuring higher visibility. 122 x 122 cm.

259⁹⁵	3360104
-------------------------	---------

C Westcott teacher's dry erase/chalk boards geometry set

5-piece set for chalkboards or dry-erase boards. Includes 1 compass, 2 L-squares (30°-60°-90° & 45°-45°-90°), 1 protractor and 1 – 60 cm ruler. Compass features an adjustable grip which fits most dry-erase markers and chalks. White plastic, with magnets and handles.

91⁹⁵	3010329
------------------------	---------

D Teacher's dry erase/chalkboard compass

Compass features an adjustable grip, which fits most markers and chalk. Draws circles up to 150 cm diameter.

22⁹⁵	3010352
------------------------	---------

E Magnetic meter stick

Sturdy plastic, with handle.

27⁹⁵	3010568
------------------------	---------

F Music staff liner

Works with chalk or white board markers. Plastic.

14⁹⁵	1200500
------------------------	---------

G Soaker Chalkboard Sponges

Can be used dry or wet.

155 x 98 x 43 mm	3⁸⁰	1201284
140 x 66 x 43 mm	2¹⁰	1205327

Felt blackboard erasers

With easy-to-grip rounded wooden back.

H Blue, white and red		
127 x 51 x 25 mm	3²⁰	3010444

I Red, White & Blue		
127 x 51 x 38 mm	5⁰⁵	3010402

J Blue		
127 x 51 x 25 mm.	2⁹⁰	3010451

Boards and Accessories

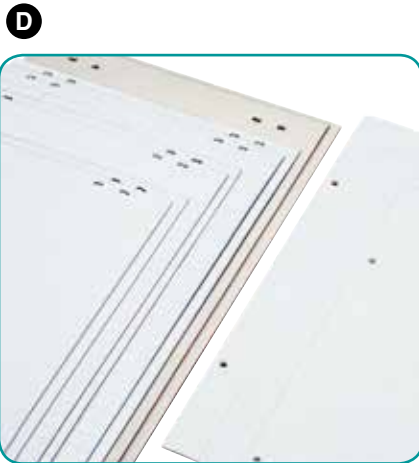
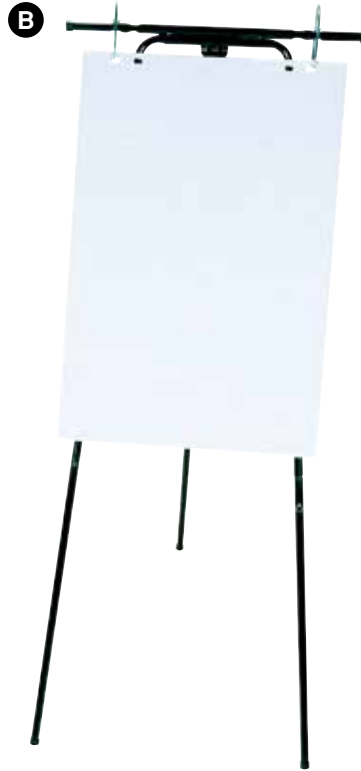

A Steel Presentation Easel

With 4 adjustable legs, to transform from a floor to a table model. Features a white board with a handy tray for markers. Maximum height: 1.7 m. Conference pad sold separately (3371671).

299⁹⁵ 3360971

B Presentation Easel with Steel Rings

For all chart pads (not included; see 3371671). 165 cm high.

185⁹⁵ 3360989

C Conference Easel – Aluminium

109⁹⁵ 3360328

D Chart Pads

Ultra sturdy back board. 61 x 85 cm. 2 holes. Used with ring or clip-style presentation easels. 2 packs of 50 sheets each (100 sheets in all).

Bond paper, ruled **23⁹⁵** 3371655
 Bond paper, graph **23⁹⁵** 3371663
 Bond paper, unruled **23⁹⁵** 3371671

Chart Pads

White bond paper. Packs of 100 sheets.

25 mm ruling, 2 holes **13⁹⁵** 3370384
 Graph 25 mm, 4 holes **12⁹⁵** 3371606
 25 mm ruling, 2 holes **13⁹⁵** 3371622

Plastiportable

ABS vinyl boards stick to magnetic chalkboards with magnetic strips. Include 1 dry-erase marker, 1 eraser and 1 magnetic strip on each of their 4 sides. Come in a cardboard tube for easy storage and carrying.

E Musical Staff

Features 4 equidistant musical staves. 160 x 110 cm. **123⁹⁵** 3360930

F Learn-How-to-Write Plastiportable Board

112 x 160 cm. **123⁹⁵** 3360922

G Plastiportable Grid with x and y Axes

Ruled with 3 8 cm squares. Red axes. 112 x 122 cm. **104⁹⁵** 3360963

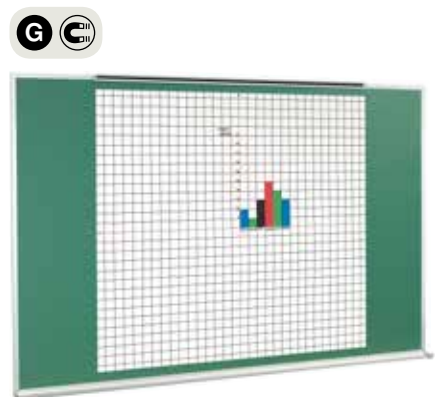

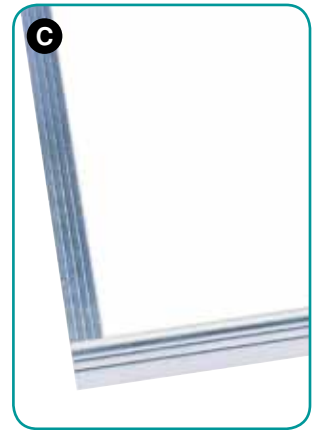

A Magnetic White Board

Dry-erase, magnetic surface. White plastic frame. Includes 2 magnets, 1 dry-erase marker and mounting hardware. 42 x 58 cm.

19⁹⁵ 3360476

B Bulletin Boards

Natural cork, aluminium frame.

122 x 122 cm **157⁹⁵** 3360435

61 x 91 cm (24" x 36") **29⁹⁵** 3360427

C Laminated White Boards

Boards designed to be used with dry-erase markers. Does not leave smudges or dust. Features easy-care aluminium frame, complete with tray for markers.

Regular

61 x 91 cm **31⁹⁵** 3360690

91 x 122 cm **48⁹⁵** 3360708

Magnetic

61 x 91 cm **55⁹⁵** 3361078

91 x 122 cm **94⁹⁵** 3361086

D Magnetic Plastic Framed Whiteboard Set

Use these highly convenient, magnetic white boards for math, reading, writing, mosaic or drawing activities (accessories not included). Plastic frame with rounded corners. 33 x 24 cm ea. Set of 6.

39⁹⁵ 2121184

E Clippable Magnetic Whiteboard

This dry-erase magnetic whiteboard can be connected to similar boards (sold separately) horizontally or vertically, using the 2 included sturdy plastic clips. Lime green frame. Convenient 40 x 30 cm size.

12⁹⁵ 3010915

F Slate Set

Set of 10 slates 23 x 30 cm.

33⁹⁵ 3170255

G Display boards

Set of 4 display boards with side flaps. White cardboard. 122 x 91.5 cm.

43⁹⁵ 1204825

Tape and Adhesives



A Magic Transparent Adhesive Tapes With Dispenser

Nbr. 810

12 mm x 33 m	3 ⁶⁰	3390606
18 mm x 33 m	4 ⁷⁰	3390614

Nbr. 6200

12 mm x 33 m	2 ⁰⁵	3395530
18 mm x 33 m	2 ⁶⁰	3395548

B Magic Transparent Adhesive Tapes Without Dispenser

Nbr. 810

12 mm x 33 m	3 ⁰⁵	3390655
--------------	-----------------	---------

C Transparent Adhesive Tapes with Dispenser

12 mm x 33 m		
Highland 500	1 ⁶⁵	3390382
Scotch 600	4 ²⁵	3390671

D Transparent Adhesive Tapes Without Dispenser

Highland 500		
18 mm x 33 m	0 ⁹⁹	3390374
Scotch 600		
12 mm x 33 m	3 ²⁰	3390473
18 mm x 33 m	3 ⁹⁵	3390507

E Magic Removable Adhesive Tape with Dispenser

#811. 18 mm x 33 m	5 ⁹⁵	3395589
--------------------	-----------------	---------

F Magic Ecologic Adhesive Tape Matte

Invisible matte finish tape, perfect for a wide range of uses. It does not appear on copies, making it the perfect tape for tasks such as permanent paper repair. Does not yellow. One can write with a pen, pencil or marker. Moisture-resistant. Tape lead is made with 100% recycled plastic and adhesive is 65% plant based.

Magic Ecological Adhesive Tape with dispenser.

19 mm x 15m	3 ⁹⁵	3340494
-------------	-----------------	---------

Refills. Pack of 2

19 mm x 23m	7 ⁴⁵	3340528
-------------	-----------------	---------

G Magic Ecological Adhesive Invisible Tape

Invisible tape. Does not yellow. Moisture-resistant. Tape lead is made of 100% recycled plastic and adhesive is 65% plant based.

Magic Ecological Adhesive Tape with dispenser

19mm x 15m	3 ⁶⁵	3340502
------------	-----------------	---------

Pack of 2 refills.

19 mm x 23m	7 ⁴⁵	3340510
-------------	-----------------	---------

H Transparent Adhesive Tapes Without Dispenser

12 mm x 66 m	2 ⁴⁵	3390986
18 mm x 66 m	3 ²⁵	3390994

K



I Adhesive Tape Without Dispenser

25 mm inner diameter. 33 m rolls.		
12 mm	1 ⁴⁰	3390960
18 mm	1 ⁸⁵	3390978

J Pritt Dry Adhesive Rollers

8 mm x 10 mm		
Permanent adhesive	5 ⁰⁵	3392255

K Magic Scotch Tape Enviro Package

14 rolls of 810 Magic Scotch tape, 19 mm x 33 m, without inner packaging, to avoid waste.	59 ⁹⁵	3390317
---	------------------	---------



A Desk Tape Dispenser

For 33 m rolls. ø 24 mm drum. Black and silver.

7⁵⁵ 3395845

B C15 Desk Tape Dispenser

For 33 m and 66 m rolls. Drum ø 25 mm. Black.

4⁵⁰ 3390101

C Bookbinding Adhesive Tape

Clear. To repair, reinforce and protect books.

38 mm x 13 m	6⁹⁰	3390226
50 mm x 13 m	9¹⁵	3390234
76 mm x 13 m	13⁹⁵	3390242
100 mm x 13 m	17⁹⁵	3390259

D Scotch Enviro Masking Tape

Solvent-free process. Tape's paper made from 30% post-consumer recycled fibers. Contains more than 60% recycled, renewable resources. 55 m rolls.

48 mm **6⁸⁵** 3390853

E First Quality 3M Masking Tape

55 m rolls.

12 mm	7⁶⁰	3390481
18 mm	9⁹⁵	3390515
24 mm	12⁹⁵	3390549
36 mm	18⁹⁵	3390564
48 mm	25⁹⁵	3390580

F Masking Tape

55 m rolls.

12 mm	1⁵⁰	3391935
18 mm	2²⁵	3391943
24 mm	2⁷⁵	3391968
36 mm	3⁷⁵	3391950
48 mm	4⁶⁰	3391976

G Coloured Masking Tape

18 mm x 55 m.

Blue	5⁵⁰	3391885
Yellow	5⁵⁰	3391893
Black	5⁵⁰	3391901
Red	5⁵⁰	3391919
Green	5⁵⁰	3391927

Tape and Adhesives

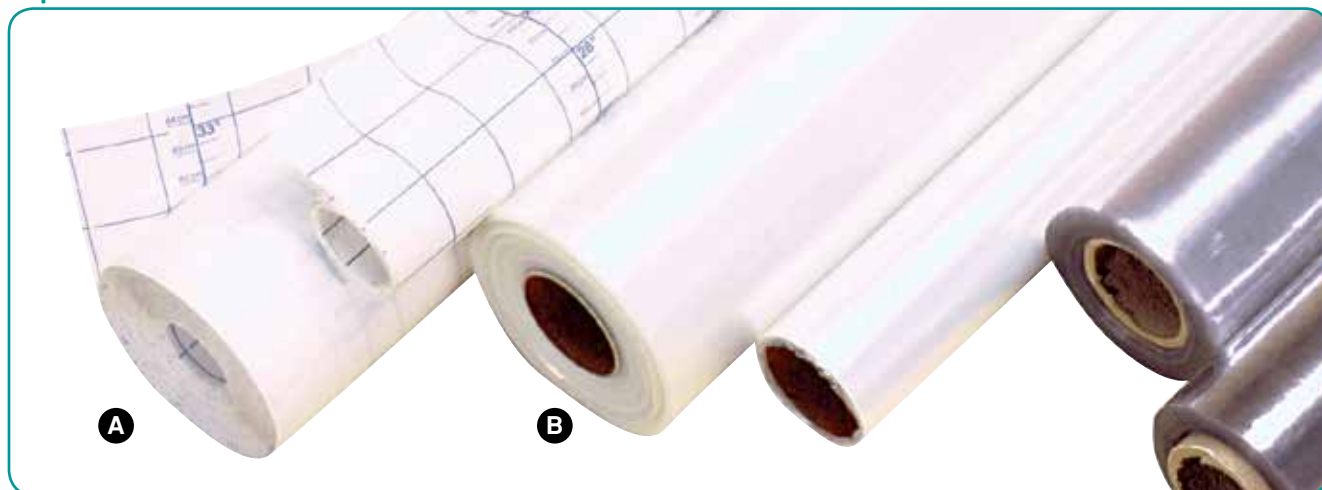

A Clear Adhesive Plastic

45 cm x 23 m
45 cm x 1.27 m

23⁹⁵ 3133618
1⁶⁰ 3133642

B Clear Plastic

22 m rolls.
60 cm wide
120 cm wide

69⁹⁵ 3133584
115⁹⁵ 3133592

C Adhesive Fabric Tape

Ideal for book repairs. 55 m rolls.

	36 mm	48 mm	72 mm
Black	3393832	3393915	3393378
Blue	3393808	3393881	3393329
Green	3393857	3393931	3393402
Red	3393840	3393923	3393394
Silver grey	3393782	3393865	3393345
White	3393790	3393873	3393311
Yellow	3393824	3393907	3393360
	7⁵⁵	10⁹⁵	13⁹⁵

D Filament Tape

Transparent. Fiberglass-embedded adhesive. Ideal to reinforce boxes, packaging, etc.

18 mm x 55 m **2⁷⁰** 3391372
24 mm x 55 m **3⁷⁰** 3391364

E Packaging Tape

Ideal to assemble boxes. Drum: ø 76 mm. 48 mm x 66 m.

2⁸⁵ 3390747

F Packaging Tape Dispenser

For tapes 5 cm wide with a 76 mm interior diameter.

14⁹⁵ 3391539



A Double-Sided Adhesive Tape
Used to mount photographs and documents. 12.7 mm x 7.6 m.
8⁹⁵ 3390143

B Magnetic adhesive tape
Magnetic adhesive strip, in a convenient plastic dispenser. Magnetic strength: 730 g/30 cm. 20 mm x 8 m.
21⁹⁵ 1201748

C Velcro-Type Adhesive Strips
Includes one strip with loops and one strip with hooks, each 2 cm x 1 m. Used for presentations, exhibitions and other mounting purposes.
6⁹⁵ 1154004

D Self-adhesive Magnetic Strips
Apply these ready-to-use strips to make a variety of small objects stick to any metal surface 1 x 5 cm. Pack of 75.
8²⁵ 1210178

E Magnetic Adhesive Tape Dispenser
Magnetic adhesive tape dispenser with cutting lever. Refillable. Magnetic strength: 3 kg/30 cm. 14 mm x 4.5 m.
24⁹⁵ 1201797

Replacement Roll
4.5 m
14⁹⁵ 1201771

F Mounting Roll Tape
Double-sided, high density, durable, adhesive foam tape. 1.3 cm x 1.90 m.
4⁷⁰ 3390135

G Self-adhesive Magnetic Strip
Cut and apply easily to make a variety of small objects stick to any metal surface.
12 mm x 3 m **3⁷⁰ 2119659**
12 mm x 30 cm **0⁹¹ 2110344**

H Double-Sided Adhesive Tape
Used to mount posters, photographs and documents. 500 g/cm resistance. 24 mm x 50 m
11⁹⁵ 3391059

I Fun-Tack Adhesive Gum
Holds posters, papers, etc. Reusable. Replaces tapes and tacks. 56 g.
2⁴⁰ 1130210

J UHU Tac Adhesive Gum
Adhesive gum. Holds posters, papers, etc. Reusable. Replaces tapes and tacks. 60 g.
3⁶⁰ 1131168

K Command Poster Strips
Firm hold and mess-free removal. Do not damage wall surface. Box of 12 strips.
2⁷⁰ 3360195

L Removable Mounting Squares
Double-sided removable squares for mounting and securing objects: posters, photos, artwork and other lightweight items. Use on wood, tile, painted walls, glass, and most other wall surfaces that are clean, dry and smooth. Adheres to painted cinder blocks, varnished wood, blackboards and glass. Weight capacity: 16 squares hold up to ½ pound. Pack of 64 squares.
4⁹⁵ 3391521

M Magnetic Ceiling Hooks
Pack of 4.
31⁹⁵ 1206499

N Drop ceiling hangers
Heavy-duty, tempered aluminum. Pack of 2.
3⁹⁰ 3176492

O Command Adhesive Hooks
Reusable hooks. Medium size. Hold up to 1.36 kg. Set of 2 hooks and 4 adhesive strips.
4⁴⁵ 3176476

Self-Adhesive Notes



A Highland Note Pads

Pack of 12 – 100 self-sticky notes.
 38 x 50 mm **3¹⁰** 3340205
 76 x 76 mm **5¹⁵** 3340213
 76 x 127 mm **9⁹⁰** 3340247

B Recycled Post-It Notes

Made from 100% recycled paper. 100 notes per pad. 3.8 x 5 cm. 24 pads per pack.
21⁹⁵ 3340288

C Auto-adhesive labels

Pack of 48 labels. 29x83mm, auto-adhesives. White with blue borders. Made of recycled paper.
1⁹⁵ 3353091

D Environment-Friendly Notes

Environment-friendly notes in assorted pastel colours. 5 – 100 note pads. 7.6 x 12.7 cm.
14⁹⁵ 3340353

E Post-It Note Pad

500 – 7.6 x 7.6 cm notes.
11⁹⁵ 3342607

F Post-It Page Markers

5 colours. 500 markers. 12 mm x 5 cm.
8¹⁵ 3390168

G Label Roll Removable Adhesive

Get the perfect length every time! Full adhesive, use it as a note or label. Sticks securely and removes cleanly. The repositionable adhesive won't mark paper and other surfaces and allows you to attach labels without staples, paper clips or tape. Use the self-adhesive to stick on papers, desks or wherever you need a note or reminder Useful dispenser. 2.54 x 10 x 16 cm.
6⁴⁵ 3340536

Post-It Specialty Notes

Brighten your students' day and hold their attention with fun, die-cut shaped notes. Approximately 7.6 cm.
H Flower **3⁹⁵** 3340338
I Emoji **3⁹⁵** 3340460
J Cupcake **3⁹⁵** 3340478
K Bubble **3⁹⁵** 3340486

L Self-Adhesive Notes

Pack of 275 self-adhesive notes of various shapes and colours. Made of 70% recycled paper.
4⁷⁵ 3353109

M Post-It See-Through Index Tabs

4 – 35 index tabs 11.9 x 43.2 mm. 140 tabs per pack.
7⁶⁵ 3390804

N Self-Adhesive Reinforcements

Used to reinforce loose-leaf holes. Pack of 560.
1¹⁵ 3202025

**A Optima 45 Electric Stapler**

Automatic, powerful and silent stapler that works with regular staples. Staples up to 45 sheets at a time. Staples flat, making thinner piles.

139⁹⁵ 3060373

B Optima 70 Desk Stapler

Ergonomic design allows to staple up to 70 sheets flat, using up to 50% less effort than with regular staplers. Guaranteed jam-free when using Optima high capacity staples (see 3060134). Flat-clinch technology lets staples lie flat against the back of documents.

58⁹⁵ 3060431

C Rapid Classic 2002 Stapler

Front-tray loading stapler. Capacity: 210 staples (full strip).

55⁹⁵ 3061959

D Ultra Economy All-Metal Desk Stapler

9⁹⁵ 3060019

E Rapid Eco Standup Stapler

Staples flat, up to 30 sheets, making the stack flatter. Contains a full strip of staples. Made of 80% recycled plastic.

21⁹⁵ 3060449

F Acme X-06051 Stapler

Top-loading. Capacity: 210 staples (full strip).

71⁵ 3064219

G Rapid 2002-16 Long Reach Stapler

40 cm long. For regular staples.

99⁹⁵ 3062015

H Standard Rapid Staples

Box of 5000. 6 mm.

2⁵⁰ 3060456

I Arrow Standard Staples

Box of 5000. 6 mm.

2³⁰ 3060191

J Optima Jam Free Staples

Jam free when using Optima staplers (see 3060373). 1/4" high. 3750 staples.

7⁷⁵ 3060282

K High-Capacity Optima Staples

Designed to improve the use of Optima staplers (see 3060431). 3/8" high. 2500 staples.

10⁹⁵ 3060134

L Staple Remover

Steel, silver polish.

1⁴⁰ 3064110

Office Supplies

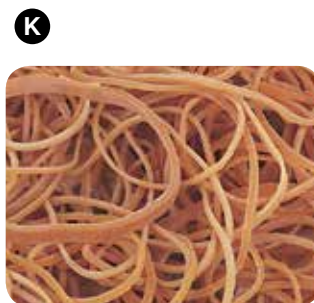
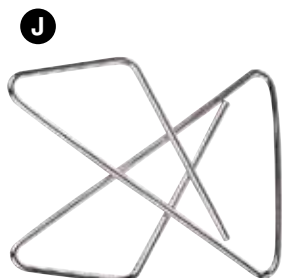

A B&B Quartz Movement Clock

Black case, white face. 24 hours. \varnothing 30 cm. Uses 1 AA battery (not included). Use of alkaline batteries is recommended for best performance.

27⁹⁵ 3032075

B Casio MS-80 Tax Calculator

8-digits. Large, easy-to-read bit display. Tax & currency exchange function. Constants for +, -, x, \div . Independent memory. Mark-up percent, positive or negative. Solar Plus with battery back-up.

10⁹⁵ 3176815

C 3M LS1000 Laminating System

Handles documents up to 30 cm wide. Takes up only 35 cm of desktop space; weighs only 6 kg.

377⁹⁵ 3176310

LS1000 Replacement cartridge

30 cm x 30.4 m

116⁹⁵ 3176328

3M LS950 Laminating System

Handles documents up to 21.6 cm wide. Takes up only 25 cm of desktop space; weighs only 4 kg. Not shown.

234⁹⁵ 3176013

Replacement cartridge

21.6 cm x 30.4 m

76⁹⁵ 3176021

D Brass Fasteners

Box of 100.

10 mm

1²⁵ 3040417

13 mm

1²⁵ 3040409

19 mm

1²⁵ 3040425

25 mm

1⁶⁰ 3040441

E Bulletin Board Plastic Tacks

Boxes of 100.

Clear

1¹⁰ 1202605

Assorted colours

1¹⁵ 3172137

F Paper Clips

Boxes of 100.

Corrugated

50 mm

1¹⁵ 3040698

Plain

25 mm

0⁴⁷ 3040516

33 mm

0⁴⁷ 3040508

G Metal Loose Leaf Rings

Metal.

19 mm

Box of 100.

16⁹⁵ 3040003

25 mm

Box of 100.

18⁹⁵ 3040052

50 mm

Box of 50.

16⁹⁵ 3040060

H Magnetic Clip

Width: 5 cm. Pack of 12.

9⁷⁵ 3041688

I Fold-back Clips

Spring hook. Boxes of 12.

19 mm

0⁴⁹ 3040557

32 mm

1²⁰ 3040565

42 mm

1⁹⁵ 3040573

50 mm

3¹⁵ 3040581

J Butterfly Paper Clamps

Metal. 38 x 32 mm. Box of 50.

2³⁰ 3040367

K Elastic Rubber Bands

57 g bag.

64 x 1.5 mm

1³⁰ 3031507

76 x 1.5 mm

1³⁰ 3031515

76 x 3 mm

1³⁰ 3031564

90 x 1.5 mm

1³⁰ 3031531

90 x 3 mm

1³⁰ 3031572

90 x 6 mm

1³⁰ 3031606

150 x 16 mm

2⁸⁰ 3030178

Assorted sizes

1³⁰ 3031440

L Plier-Type Conductor's Punch

\varnothing 6 mm hole. With receptacle.

2⁹⁰ 3280286

**3-hole Paper Punches**

3-hole Paper Punches

A 30 sheet capacity **72⁹⁵** 3280278**B** 10 sheet capacity **12⁹⁵** 3281623**Acid-free 90 g/m2 (24 lb) Bond paper**

Acid-free Bond paper in bright colors that will add a touch of color to your correspondence. Works well in laser and inkjet printers, photocopiers and offset printers. Recyclable. Pack of 500 sheets. 8½ x 11 in.

C Bright Colours **39⁹⁵** 1351931**D** Fashion Colours **39⁹⁵** 1351949**E Swingline Heavy-Duty Paper Punch**

3 holes. 30-sheet capacity.

68⁹⁵ 3281557**F Swingline Light Touch Lever Professional Punch**

Adjustable 2-3 hole heads. 50% less effort than comparable punches. 12 sheet capacity.

35⁹⁵ 3280070**G Sorter Rack**

7-section desk sorter. Black wire. 26 x 22 x 30 cm.

12⁹⁵ 3112125**H Stackable Letter Tray**

Letter size, self-stacking, plastic, black. Capacity: 2.5 kg.

5²⁵ 3110434**I Desk Organizer**

Two compartments for writing instruments, two areas to hold clips, tacks and more, angled area for note pad and sorting vein for envelopes. Black plastic. Accessories not included.

11⁹⁵ 3110418**J Hand Bell**

Brass, with varnished wood handle.

85 mm **42⁹⁵** 3170461150 mm **93⁹⁵** 3170479

Filing



A



B



E

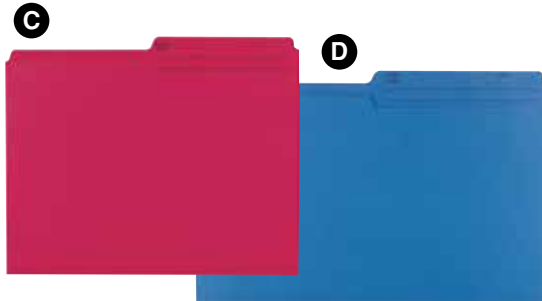

C

D



G

H



F



I



J

A Pendaflex hanging organizer

Hanging organizer with case including 6 removable cascading pockets and a build-in hook. Letter Size.

27⁹⁵ 3134764

B Dymo Letra Tag LT-100H Label Maker

Compact label maker, simple and fast. Automatic switch to save energy. Requires 4 AA batteries (not included).

49⁹⁵ 3152709

Dymo Letra Tag Label Tape Refills

12 mm x 3.6 m roll. Black on white. Easy to clean. Water resistant. Plastic. Not illustrated.

9⁹⁵ 3152782

File Folders

Reversible. Letter-size and legal-size. Box of 100. 10.5 points.

C Letter

Blue	25⁹⁵	3131794
Green	25⁹⁵	3131802
Ivory	24⁹⁵	3131976
Kraft (9.5 points)	19⁹⁵	3131844
Orange	25⁹⁵	3131810
Red	25⁹⁵	3131588
Yellow	25⁹⁵	3131570

D Legal

Blue	28⁹⁵	3131521
Green	28⁹⁵	3131539
Ivory	28⁹⁵	3131984
Kraft (9.5 points)	26⁹⁵	3131851
Orange	28⁹⁵	3131547
Red	28⁹⁵	3131513
Yellow	28⁹⁵	3131562

E Business Envelopes – Brown Kraft

Open end. 23 x 30.5 cm. Box of 500.

67⁹⁵ 3190394

F Label Holders

For hanging file folders. Clear, flexible plastic. Includes white labels. Box of 25.

51 mm **2⁵⁵** 3131752

76 mm **2⁵⁵** 3131760

Labels for Holders

White. Width: 51 mm. Pack of 100.

2⁸⁰ 3131737

G Hanging File Folders

Plastic label holders not included. Box of 25.

Letter

Blue **16⁹⁵** 3132016

Green **11⁹⁵** 3131711

Red **16⁹⁵** 3131992

Yellow **16⁹⁵** 3132008

Legal

Blue **18⁹⁵** 3132040

Green **14⁹⁵** 3131729

Red **18⁹⁵** 3132024

Yellow **18⁹⁵** 3132032

H Rack for File Folders

Metal. Expandable for letter and legal-size.

19⁹⁵ 3131836

I Storage File

Sturdy construction, easy to use even when stacked. Depth: 60 cm. Legal size.

23⁹⁵ 3110160

J Corrugated Cardboard Storage Box

With removable lid. Used for storing files. Compatible with letter and legal sizes.

8⁹⁵ 3111192



A Plastic Tang Portfolios

Black	1⁹⁵	3131000
Green	1⁹⁵	3130705
Grey	1⁹⁵	3131620
Light blue	1⁹⁵	3130275
Light green	1⁹⁵	3131646
Orange	1⁹⁵	3130291
Pink	1⁹⁵	3131638
Purple	1⁹⁵	3131612
Red	1⁹⁵	3130408
Yellow	1⁹⁵	3130283

B Plastic Report Cover with Pockets

1 pocket on each side. Single unit.
Assorted colours **1⁸⁰** 3130366

C Plastic Report Cover – 4 Pockets

Assorted colours. Per unit. **1⁵⁰** 3130440

D Report Cover With Pockets

Without fasteners. 28 x 21.6cm. Per unit.

Black	0⁵⁶	3132131
Blue	0⁵⁶	3132420
Green	0⁵⁶	3134012
Yellow	0⁵⁶	3132412

E Clipboard

Letter size clipboard. Made of sturdy Expanded polypropylene. Lively shades and modern design. Available in 6 colours.

Cyan	4²⁰	3250057
Green	4²⁰	3250032
Orange	4²⁰	3250024
Pink	4²⁰	3250008
Red	4²⁰	3250065
Yellow	4²⁰	3250016

G Plastic Folder

Folder for documents. Legal size.

Blue	1³⁰	3130077
Clear	1³⁰	3131356
Red	1³⁰	3130648

H Expandable Punched Plastic Envelopes

Smart tool to have all workbooks properly organized. Letter Size. Velcro® closure. Hole-punched, to fit in standard ring binders. Translucent. Assorted colours. Sold individually.

1³⁵ 3133097

F Plastic Report Cover – 3 Compartments

Perforated with 3 holes. 4 assorted colours. Per unit.

2⁵⁰ 3130432

Binders and Covers

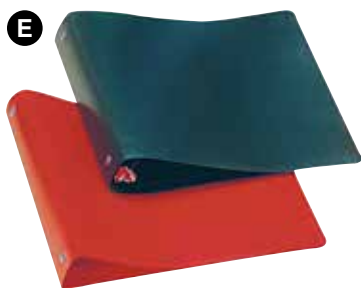

A Tang Covers – Regular

28 x 21.6 cm. 3 metal fasteners. Per unit.

Box of 25 covers in assorted colours

Black

Dark blue

Green

Grey

Medium blue

Orange

Red

White

Yellow

13⁹⁵ 3132230

0⁶¹ 3132297

0⁶¹ 3132255

0⁶¹ 3132347

0⁶¹ 3132289

0⁶¹ 3132263

0⁶¹ 3132313

0⁶¹ 3132339

0⁶¹ 3132248

0⁶¹ 3132305

B Tang Covers – with Pockets

With 2 inside pockets and 3 metal fasteners. Assorted colours.

Box of 50

67⁹⁵ 3130168

C Tang Covers – Laminated Series 34000

3 metal fasteners. Per unit.

Black

Blue

Dark blue

Green

Grey

Orange

Red

White

Yellow

0⁹⁹ 3130465

0⁹⁹ 3130457

0⁹⁹ 3130473

0⁹⁹ 3130499

0⁹⁹ 3130481

0⁹⁹ 3130531

0⁹⁹ 3130549

0⁹⁹ 3130622

0⁹⁹ 3130630

D Tang Covers – Laminated

Superior quality. 28 x 21.6 cm. 3 metal fasteners. Per unit.

Black

Dark blue

Red

1⁷⁰ 3132206

1⁷⁰ 3132321

1⁷⁰ 3132396

E 3 Ring Binders – Accoring Type

Flexible vinyl cover. 28 x 21.6 cm. Per unit.

15 mm capacity

25 mm capacity

2⁵⁵ 3133394

3⁰⁵ 3133402

F 3 Ring Binders – O Type

Hardcover. 28 x 21.6 cm. Assorted colours. Per unit.

25 mm capacity

33 mm capacity

50 mm capacity

2⁷⁵ 3250081

4⁶⁵ 3250099

4⁹⁰ 3250107

G 3 Ring Binders – D Type

Hardcover. 3 D-type rings. Back and front presentation pockets. Interior pockets.

	25 mm	38 mm	50 mm	76 mm
Black	3251329	3251428	3251527	3251626
Blue	3251311	3251410	3251519	3251618
Green	3251352	3251451	3251634	
Red	3251337	3251436	3251535	
White	3251345	3251444	3251543	
	4⁴⁵	5²⁵	6⁸⁰	8⁵⁰

Loose Leaf Sheets and Dividers



Quad Ruled Loose Leaf Sheets

28 x 21.6 cm.

A 1 cm square

100 sheets **8⁷⁰** 3210044

B 6 mm, 4 squares per inch

50 sheets **3⁴⁵** 3210234

C Ruled Loose Leaf Sheets

7 mm, with margin. 28 x 21.6 cm. 200 sheets.

3²⁰ 3210523

Plastic Dividers

Extremely resistant, will not tear.

D 5 sections **1⁴⁵** 3220035

E 8 sections **2¹⁵** 3220043

F 10 sections **2²⁵** 3220001

G Vinyl Dividers

With laminated tabs, in assorted colours.
For 3-ring binders. 28 x 21.6 cm.

5 index tabs **1²⁰** 3221173

8 index tabs **1⁶⁰** 3222031

H Cardboard Dividers

Printed with class schedule. For 3-ring binders. Pack of 5 colours. 28 x 21.6 cm.

1²⁰ 3221702

I Vinyl Protective Pockets

For 21.6 x 28 cm sheets.

With standard hole punching.

Pack of 10 **1¹⁰** 3132842

Pack of 100 **8⁴⁰** 3135837

J Clipboards

Masonite, with spring clamp.

Letter size **2⁴⁰** 3250883

K Examination Paper

Loose-leaf sheets, ruled on both sides, with margin. 8 mm. 20 x 33 cm. 500 sheets.

9³⁵ 3271186

L Figuring Pads

White bond paper. 96 sheets.

Ruled 8 mm **2³⁵** 3370400

Ruled 6 mm **2³⁰** 3370939

M Figuring Pads

White bond paper. 96 sheets.

6 mm Square **2³⁵** 3370947

N Examination Pads

Interlined. 17.8 x 22.8 cm. 24 sheets.

2⁶⁰ 3370475

Planning Guides

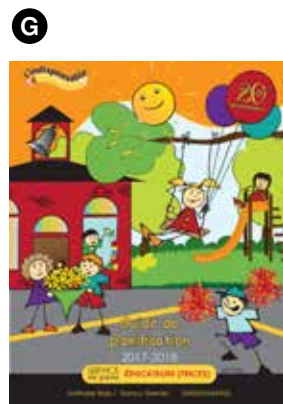
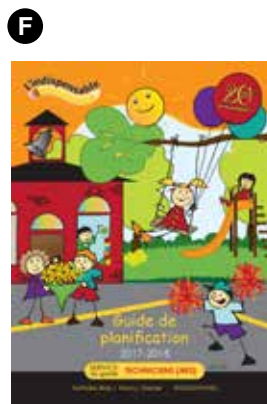
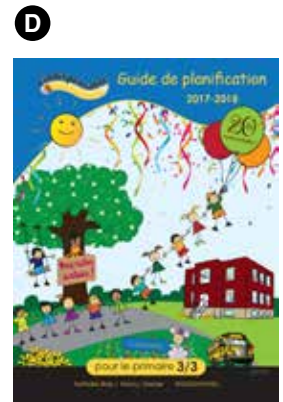
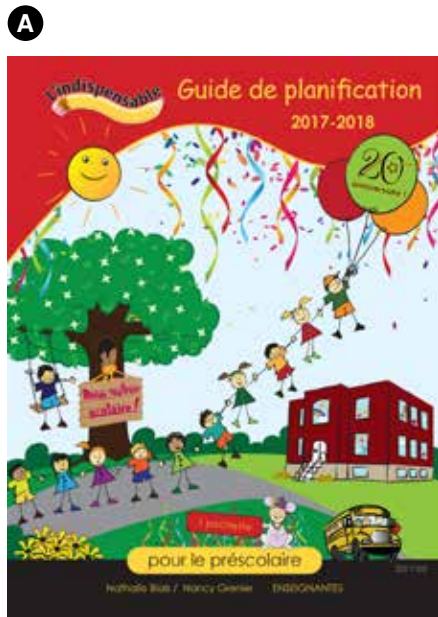

L'indispensable – Class Planning Guides

Available in French only.

- A** Préscolaire
- B** Primaire 4/2
- C** Primaire 3/2
- D** Primaire 3/3
- E** Spécialiste
- F** Technicien(ne) de service de garde
- G** Éducateur(trice) de service de garde

27⁹⁵ 2220028
27⁹⁵ 2220010
27⁹⁵ 2220044
27⁹⁵ 2220077
27⁹⁵ 2220036
27⁹⁵ 2220051
18⁹⁵ 2220069

H Preschool (in French)

For preschool level teachers. A week-at-a-glance. Includes transcripts. In French.

23⁹⁵ 3072998

I Daily Teacher Plan Books and Transcripts

For use in elementary level classes taught by a single teacher.

Coil bound

English
 French

29⁹⁵ 3070802
29⁹⁵ 3070828

J Daily teacher plan books and transcripts

For use in elementary and high school level classes, on a rotational teaching system.

Coil bound

English
 French

29⁹⁵ 3070810
29⁹⁵ 3070836



Large Hilroy Exercise Books

27.6 x 21 cm, 3 holes.

40 pages

A Graph 6 mm **0⁹²** 3071933

B Ruled and marginated 7 mm **0⁹⁴** 3072956

C Ruled and marginated 8 mm **1⁰⁵** 3073020

80 pages

D Ruled and marginated 8 mm **1⁴⁵** 3071123

E Ruled and marginated 7 mm **1⁴⁵** 3071131

Small Hilroy Exercise Books

23.2 x 18.1 cm.

28 pages

F Interlined and dotted large **1¹⁵** 3071107

32 pages

G Interlined and marginated **1⁰⁵** 3070083

40 pages

H Unruled **0⁹²** 3070166

I 1/2 blank 1/2 ruled **0⁹²** 3071115

J Ruled **0⁸⁴** 3071156

K Ruled 3/16" **0⁹²** 3071495

L Ruled 8 mm **0⁹²** 3071503

M 1/2 blank 1/2 ruled **0⁹²** 3071990

N Ruled and marginated **0⁹²** 3072949

72 pages

O Interlined-dotted **1¹⁰** 3071917

80 pages

P Ruled and marginated **1²⁰** 3070174

Q Coil Notebooks

27.6 x 21 cm.

Graph 80 pages **4⁴⁵** 3071222

R Coil Notebooks

27.6 x 21 cm.

Ruled

200 p. **5⁶⁵** 3072204

S Coil Notebooks

27.6 x 21 cm.

Rules

80 pages **2⁴⁰** 3072295

T Coil Notebooks

27.6 x 21 cm.

Graph 5 mm

80 pages **4⁹⁵** 3072360

U Coil Notebooks

27.6 x 21 cm.

For Sciences and Maths

One side ruled and marginated, one side unruled. 80 p. **4²⁰** 3072493

V Scrapbook – Manilla

20 pages, 30.5 x 22.9 cm.

2⁶⁰ 3080025

W Scrapbook – Newsprint

72 pages, 38 x 28 cm.

2⁵⁰ 3080603

X Scrapbook

Coil binding, manilla paper, 40 pages, 35.6 x 27.9 cm.

3⁵⁰ 3080611

Y Project Book

30 x 22 cm, 3/4 page unruled, 1/4 page ruled. Cartridge paper. 32 pages.

1⁸⁰ 3080108

Notebooks

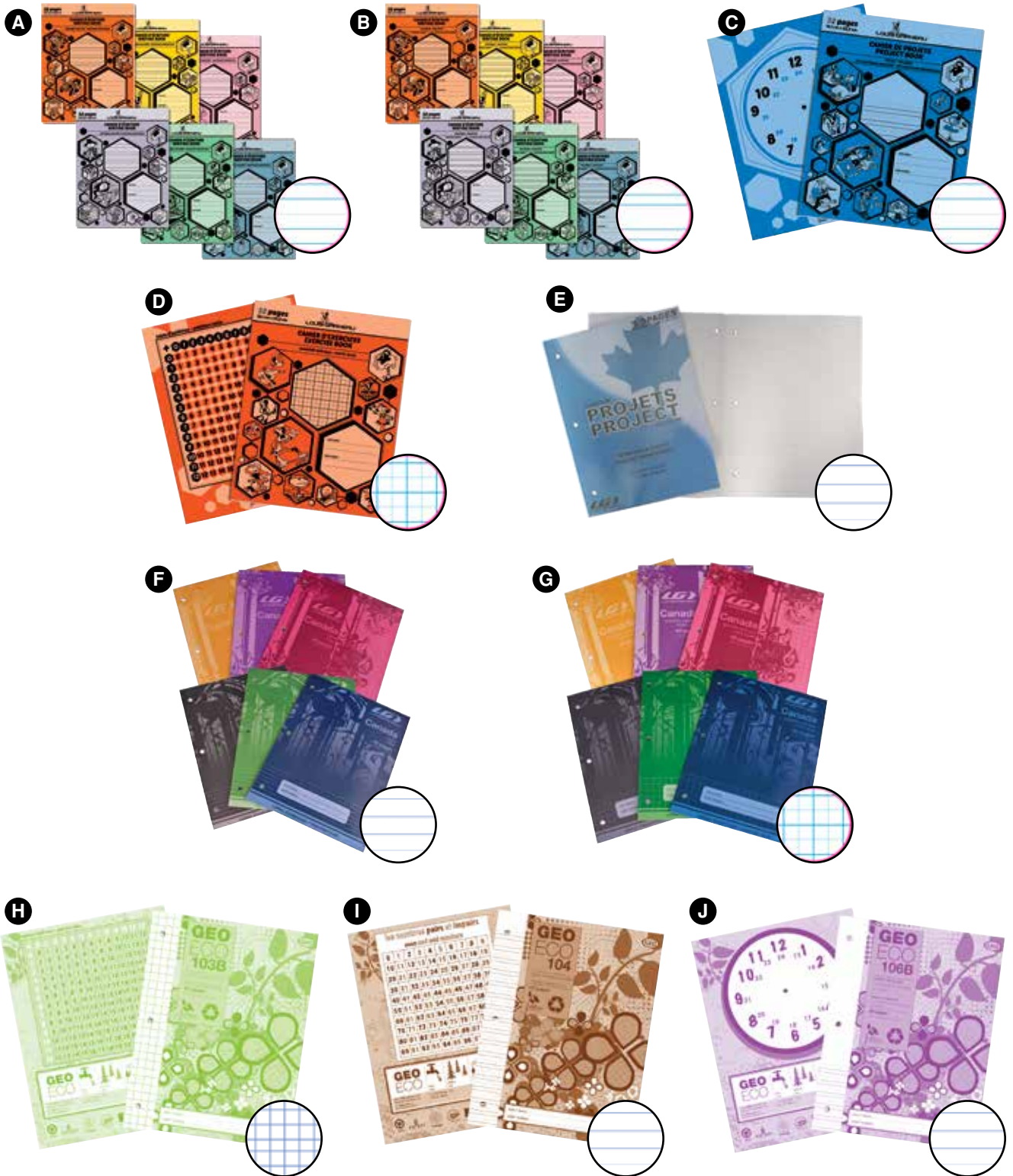

Small Louis Garneau Exercise Books

23.2 x 18.1 cm. Laminated cover, thicker paper. 32 pages. Assorted colours.

A Ruled-Dotted – LG10

Assorted colours

1³⁰ 3070075

B Ruled and Marginated – LG20

1³⁰ 3070091

C Projects Book – LG30

1/2 unruled, 1/2 interlined-dotted.

1³⁰ 3070109

D Centimeter Metric Graph – LG40

1³⁰ 3070067

Large Louis Garneau Exercise Books

27.6 x 21 cm. 3 holes. Laminated cover, thicker paper.

E Project Book

32 pages. 2/3 unruled, 1/3 ruled 7 mm. **1⁵⁰** 3070042

F Canada Exercise Book

40 pages. Ruled 7 mm. **1⁵⁰** 3070059

G Metric Graph Book

40 pages. **1⁵⁰** 3073335

Books – Geo Ecolo Series

Series of books made entirely in Québec. A responsible and environment-friendly choice. 40 pages, standard 3-hole punch. 27.6 x 21.3 cm.

H Quad ruled 1 cm

2¹⁵ 3070323

I Interlined-Dotted 1 cm

2¹⁵ 3070331

J Interlined-Dotted Project

2/3 blank, 1/3 interlined-dotted. **2¹⁵** 3070364

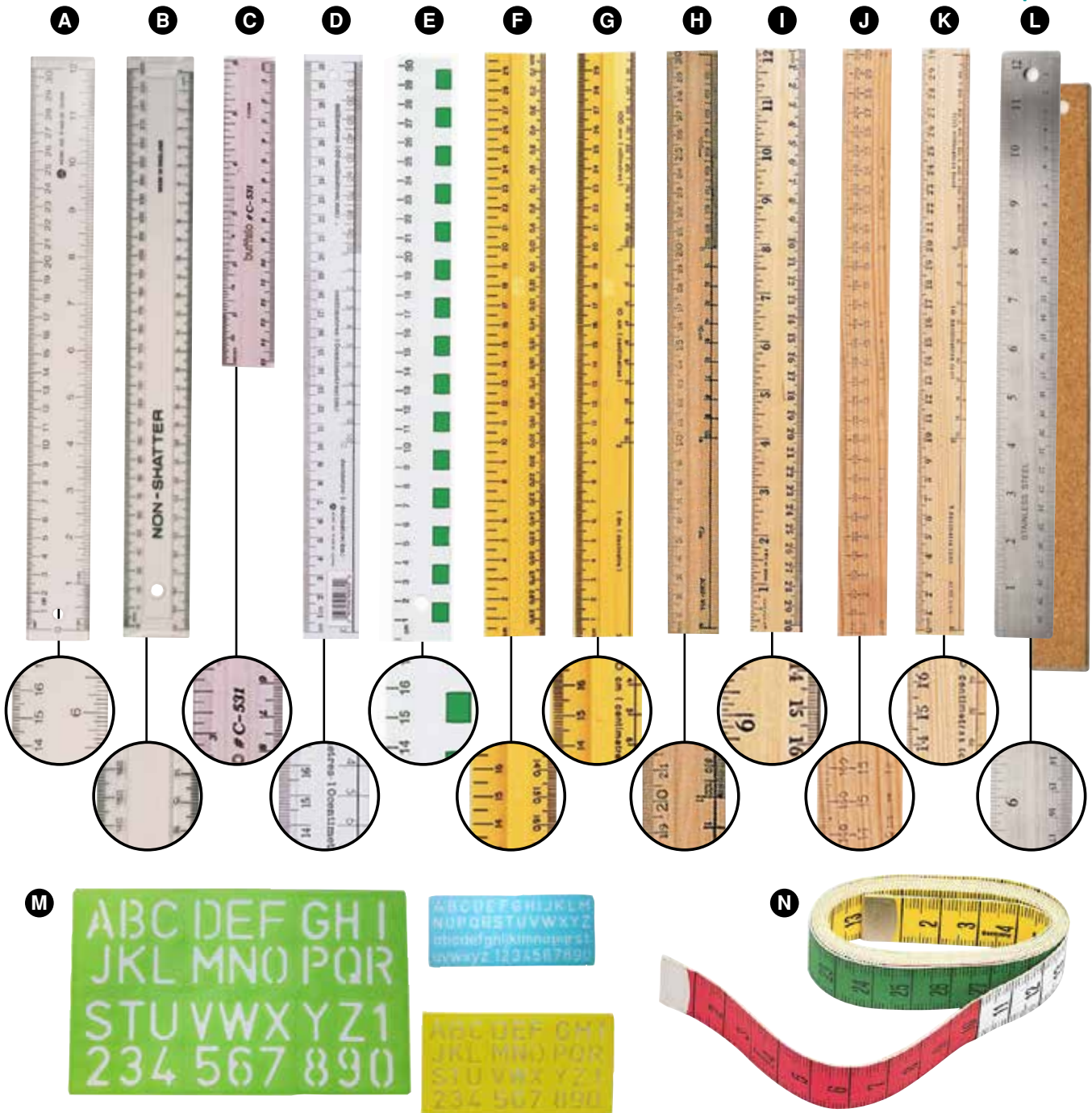

A Acrylic Ruler
30 cm. Acrylic. Graduated in cm and inches.
2⁷⁵ 3310570

B Plastic Ruler
30 cm. Clear. Graduated in mm, cm and dm.
Shatter-resistant.
1⁴⁵ 3310794

C Plastic Ruler
15 cm. Clear. Graduated in cm and mm.
0⁴⁹ 3310398

D Plastic Ruler
30 cm. Clear, flexible.
Graduated in mm, cm, and dm.
0⁵⁵ 3310513

E Plastic Ruler Opaque
30 cm. Graduated in cm (Grades 1-2).
0⁸⁰ 3310737

F Plastic Ruler Opaque Junior
30 cm. Graduated in mm and 0.5 cm.
0⁸⁸ 3310422

G Plastic Rulers Opaque Intermediate
30 cm. Graduated to demonstrate the relation between dm, cm and mm.
0⁸⁸ 3310430

H Wooden ruler
30 cm. Graduated in mm, cm, and dm.
1³⁰ 3310075

I Wooden ruler
30 cm. Graduated in mm and 1/16".
1³⁰ 3310687

Wooden Rulers
30 cm. Graduated in mm, cm, and dm.

J Flat, with embedded edge **1²⁰** 3310604

K 2 bevelled edges **1¹⁵** 3310158

L Stainless Steel Rulers
With cork back.
Graduation in inches, mm and cm.
30 cm **2⁹⁵** 3310018
45 cm **7⁷⁰** 3310034
60 cm **11⁹⁵** 3310042

M Letters and Numbers Stencils
Set of 3 letters and numbers stencils.
10, 20 and 30 mm. **1⁹⁵** 3340072

N Measuring Tape
Fiber glass. Changes colour every 10 cm. 1.5 m. **2⁹⁵** 2260271

Geometry Sets



A Drafting and Geometry Set

9 pieces: compasses, ruler, 30°/60° and 45°/90° L-squares, protractor and pencil. In a metal box.

2⁸⁵ 3000304

B Drafting and Geometry Set

10 pieces. In a metal box.

1⁹⁰ 3000379

C Staedtler Geometry Set

9-piece set includes compasses, lead case, eraser, protractor, 45° and 60° L-squares, 15 cm ruler and 0.5 mm mechanical pencil. In a resistant plastic box.

10⁹⁵ 3320223

D Stop and Safe Compass

Plastic ergonomic and safe compass. Spike automatically retracts when the compass legs are closed. Leg tightening thumbwheel and locking knob. Ergonomic and comfortable grip. Perfect for small hands

3⁴⁰ 3000163

E Staedtler Compass with Accessories

This set includes an extension to trace large diameter circles, and a universal adapter to trace circles with all drafting and writing instruments measuring up to 11 mm. Includes a case for 4 HB leads.

12⁹⁵ 3320132

F Staedtler Mars Comfort compasses

Metal. 15 cm.

15⁹⁵ 3320397

G Staedtler Mars Comfort Compasses

Made of plastic and metal. Without hinged lead. With spare parts. 15 cm.

16⁹⁵ 3320728

H Staedtler Universal Template

Features 42 assorted figures such as circles, squares, triangles, and more. With dimensions printed in fractional inches with equivalencies in decimals and millimetres. 24 x 14 cm.

9²⁰ 3322880

I Staedtler Metric Circle Template

Features 41 circles, from 2 to 34 mm. With 20 cm edge scale 12.7 x 21.6 cm.

7⁹⁰ 3323268

J Semi-Circular Protractor

Clear plastic. 180°.

0⁴⁹ 3000205

K Thamographe

New, all-in-one instrument used to measure and trace geometric figures. Replaces a math compass, ruler, protractor and set square. No sharp edges means no injuries. Features a central rule for simpler, faster, neater and more precise tracing, the pencil never leaving the sheet. Trace circles with a 10-110 mm radius, precise to the millimetre. Use with a hard lead pencil (3H or 2H) or a fine point marker. Sturdy plastic. 14.5 x 6 cm.

9⁹⁵ 3012234



A B&B Black Fabric Apron
Black apron made of 65 % polyester and 35 % cotton. Size: 27.5" wide x 31.5" long. Machine washable and dryer safe.
22⁹⁵ 1204346

B Plastic Apron
White plastic apron. Pack of 10.
9⁹⁵ 1055938

C White Aprons
Plastic. Pack of 100.
57⁹⁵ 1050335

D Orangel soap 3.6L with pump
Antibacterial hand cleaner white lotion with abrasive pumice, citrus-based solvent that can be used with or without water. It quickly and naturally removes the most stubborn stains such as: rust, grease, paint, tar, urethane, carbon, varnish, spruce gum, mastic, carbon, resin, cement, adhesives, ink. It is also very effective for stains on clothing and leatherette automaker. Its unique formula combines exceptional cleaning power of orange oil with recurring effects of pumice. Comes in a convenient pump. 3.6 L.
19⁹⁵ 1209923

E Instant Hand Sanitizer
Denatured alcohol-based gel, biodegradable, with lanolin, glycerin and aloe.
500 mL Bottle With pump. **7⁰⁵** 2121499
4 L Refill Not shown. **28⁹⁵** 2121507

F Facial Tissue
2-ply facial tissues. 100 tissues per box.
43⁹⁵ 3176831

G Drinking Straws
Plastic, 20.3 cm. Box of 500.
2⁹⁰ 1202167

H Vinyl Gloves
Vinyl medical examination gloves. Non-sterile. Single use. Lightly powdered. Medium size. 100 gloves per box.
15⁹⁵ 2330942

I First-aid Kit Belt
This portable first-aid kit is a must-have for all field trips. It complies with the requirements of the Ministère de la Famille et de l'Enfance.
32⁹⁵ 5013412

J Eco-Friendly Whiteboard Cleaner
Environmentally-friendly, citrus-based cleaner removes stubborn marks and stains on whiteboards. Spray bottle.
237 mL (8 oz) **4⁶⁰** 3297371
650 mL (22 oz) **11⁹⁵** 3292851
3.6 L (128 oz) refill Not shown. **36⁹⁵** 3292323

K First-aid kit
Institutional-grade first aid kit, conforms to Ministry regulations. Contains antiseptic towelettes, alcohols swabs, small bandages, gauze rolls, triangular bandages, thermometer, first aid manual, examination gloves and more.
94⁹⁵ 5013404

Art & School Supplies Catalog 2019 • 2020

A

3 ring binders	464
Accessories to decorate	426, 438
Acetates	433, 449
Acrylic	314
Acrylic (markers)	315
Acrylic plates	396
Adhesive gum	405, 457
Adhesive plastic	456
Adhesive tape	406, 454, 456, 457
Alginate	391
All purpose glue	404
Aluminium plates	425
Applicator tubes	325
Aprons	335, 471
Art papers	366, 368
Art sand	422

B

Beads	421
Bellows	325
Bells	420
Blackboards	451
Blackboard chalks	450
Blackboard erasers	451
Blades	399
Bogus paper	361
Bond paper	361, 366, 461
Bookbinding glue	404
Bordettes	372
Bowls	325
Brass fasteners	460
Bristol cardboard	365
Bristol paper	375
Brush markers	349
Brush stands	334
Brush washers	333
Brushes	327, 328, 333
Bulletin boards	453
Buttons	420

C

Calculators	460
Calligraphy	319, 452
Calligraphy marker	349

Canada exercise books	467
Canvas bags to decorate	352
Canvas boards	377
Canvas clips	377
Canvas paper	374
Canvas rolls	377
Caps	312
Cardboard rolls	372
Cardboard	365, 370, 422
Cardboard cones and tubes	425
Cardboard plates	425
Caribou cardboard	365
Carton	365
Cartridge paper	361
Carts	413
Ceiling hooks	406, 457
Cellophane paper	370, 426
Ceramic blades	399
Chalkboards	450
Chalkboard erasers	451
Chalkboard holders	450
Charcoal	356-358
Charcoal erasers	359
Charcoal paper	374
Cheese cloth	391
Chisels	381
Chromatic Colour Wheel	340, 414
Clay	392
Clay and accessories	392, 393
Cleaning erasers	359, 445
Clear plastic	456
Clip boards	463
Clocks	460
Clothes pins	424
Clown noses	432
Coffee sticks	424
Colour blenders	355
Colour pencils	354, 355
Comics	433, 442
Compasses	470
Construction paper	363
Cookie cutters	390
Copper wire	398
Cork lids	424
Corrector tapes	446

Corrugated cardboard	372
Cotton wool	416
Crackle mediums	316
Craft sets	416
Crayons	341-343
Crepe paper	369
Cutters	376
Cutting mats	399

D

Decorative paper	368, 430, 431
Diffusion paper	367
Display boards	453
Dividers	465
Donvale cardboard	364
Drawing methods	433
Drawing paper	350, 361
Drawing pencils	357, 358
Drawing pens	319
Dry erase boards	338, 453
Dry erase pencils and crayons	448

E

Earthenware	392
Easels	338, 339
Embossing materials and tools	379
Emotions	337
Engraving aluminium	379
Engraving pastes	378
Envelopes	462
Erasable markers	349
Erasers	359, 445
Eraser holders	359, 445
Ergonomic brushes	325, 333
Ergonomic pencils	355
Ethnicity	355
Examination paper and pads	465
Exercise books	467, 468
Eyes	420, 427
EZ Tracer	433

F

Fabric crayons	352
Fabric markers	351
Fabric tape	456

Fadeless paper	362, 366, 370, 372
Feathers	420
Felt	371
Felt pens	349, 442
Filament tape	456
Finishes	359
First aid kits	471
Foam	371, 418, 427
Foam board and accessories	376
Foam paintbrushes	333
Foam shapes	405, 418, 419
Fun tack	405, 457

G

Gel crayons	342
Gel glue	404
Geometry sets	451, 470
Gesso	317
Glass jars	438
Glitter glue	423
Gloves	471
Glue guns	405
Glue Sticks	403, 405
Graph books	467
Graph paper	465
Graphite leads	444
Graphite pencils	357, 444
Guillotines	402

H

Hand sanitizers	471
Hanging file folders	462
Heat gun	397
Hooks	457
Hooks for suspended ceilings	406, 457

I

Illustration cardboard	365
Indian ink	318, 319
Indian ink brushes	319
Inks	318
Ink extenders	383
Ink pads	336
Ink paintbrushes	329
Inking plates	381

Iron-On beads	438
---------------	-----

J

Jewellery making accessories	408, 436, 437
Jute	371

K

Knitting accessories	435
Knitting looms	435
Kraft paper	361, 362

L

Labels	462
Label holders	462
Lacing and stringing	420, 421, 434
Laminating machine	460
Lesson preparation	466
Letter trays	461
Linocut	380
Linocut rollers	381
Linoleum tiles	380
Liquid paper	446
Liquid tempera	309-312
Loose leaf sheets	465

M

Magnetic boards	407
Magnets	406, 457
Make up and accessories	432
Make-up (water-based)	432
Mangas	442
Manga papers	350
Manilla paper	361
Markers	346, 348, 350, 442
Masking tape	455
Masks	439
Mayfair cardboard	365
Measuring tapes	398, 469
Mechanical pencils	444
Mesh	391
Metallic foil	370
Miracolor Tempera	312
Mirrors	433
Mix-media paper	374, 375
Mod Podge	316, 317

Model Magic	388	Paper roll dispensers	362	Reflection	433	Silhouettes for painting	427	Tape dispensers	454, 455
Modeling clay tools	336, 390	Paper rolls	338, 361, 362, 370, 372	Report covers	463	Silk paper	369	Tempera	320
Modeling pastes (acrylic)	317	Paper sorters	412	Resist gum	319	Silk screens	383	Tempera blocks	309, 320
Modeling clay and accessories	385-389, 390	Paper stands	411	Retardants	316	Sketch crayons	356	Tongue depressors	424
Mosaics	431	Pastels	344, 345, 353, 356	Rice paper	362	Sketch pencils	357, 358	Tooth picks	424
Moulding (Worbla)	397	Pastel crayons	344, 345	Rolls	336, 390	Sketchbooks and pads	373, 375	Totes to decorate	352
Moulding latex	391	Pattern paper	368	Rubber cement	404	Slate	453	Tracing paper	373
Moulds	391	Pen brushes	320	Rubber foam	371, 418	Smart-Fab	371	Transparent glue	404
Mounting tabs	406, 457	Pencils	444, 447	Rubber tiles	380	Smocks	335	Trays	407
Mulberry paper	366	Pencil grips	444	Rulers	376, 469	Soaps	334, 471	Trimmers	402
Multicultural pencils and crayons	355	Pencil sharpeners	359, 445			Soap stone	395	Trowels	333
Music staff liners	451	Pens	349	S		Solvents	334	Two-Tone paper	366, 370, 372
Musical staves	452	Permanent markers	447	Safety equipment	398	Specialized scissors	400, 401, 408		
N		Pipe cleaners	417	Safety glasses	398	Spiral notebooks	467	U - V - W	
Newskraft paper	36	Pipettes	325	Sand and water bins	387	Sponges	325, 451	Utility knives	399
O		Plaster of Paris	391	Sand moulds	387	Squeezegees	383	Varnishes	312, 316, 317
Organizers	407, 410, 461, 462	Plastic film	460	Sand toys	387	Stained glass paint	321	Velcro	406, 457
Origami paper	366, 367	Plastic place mats	390	Sanding pads	359	Stained glass paper	368, 370	Vellum paper	375
P		Plastic tableclothes	335	Scissors	400	Stamps	336	Washable markers	346, 347
Paint containers	323, 324, 425	Plastiportable	452	Scissors for children	400, 401	Staples	459	Water containers	325
Paint scrapers	325	Playfoam Modeling clay	387	Scrap books	373, 467	Staple guns	398	Water markers	348
Paint trays	309, 323, 324	PlayMais®	429	Scratch acetates	378	Staple removers	459	Watercolour	353
Paintbrushes	327-332	Pompoms	417	Scratch foam	380	Staplers	459	Watercolour (crayons & pencils)	344, 353
Paintbrush cases	334	Portfolios	414	Scratch papers and cardboards	378	Stencils	337, 427, 470	Watercolour paint	320
Paintbrush cleaners	334	Pouring mediums	316	Scratch tools	378	Storage bins and boxes	387, 407-410, 412, 413, 462	Watercolour paint brushes	329
Painting bottles	323, 325	Presentation easles	452	Screen printing fillers	383	Storage cabinets	339	Watercolour paper	374
Painting bowls	323	Presses	381, 382	Screen printing film	383	Storage units	407, 409	Water-less hand cleaners	334, 471
Painting knives	333	Printing ink	382, 383	Sculpting stone	395	Straws	471	Weaving looms and accessories	434
Painting personages	427	Printing paper	382	Sculpting tools	394, 395	Stretched canvas	377	White boards	338
Painting rolls	325, 336	Printing plates	380	Seamless paper	361	Stretcher frames	377	White glue	403, 404
Painting trays	324	Projectors	433	Self-adhesive magnet strips	406, 457	String	434, 437	Whiteboard cleaners	471
Palettes	324	Protection equipment	398	Self-adhesive notes	458	Stumps	357	Whiteboard erasers	448
Paper bags	425	Protractors	470	Self-adhesive reinforcements	458	Styrofoam plates	324	Wikki Stix	435
Paper clips	460	Q		Self-stick magnetic strips	406, 457	Styrofoam shapes	396, 398	Wire	393, 398
Paper cutters	402	Quilling	371	Self-stick plastic	456	Symmetry	433	Wood for engraving	396
Paper dryers	411	R		Sequins	422	T		Wood-burners	398
Paper mâché	391, 404	Rack file folders	462	Shape it	387	Tactile paint	310	Wooden sticks	424
Paper punches	460, 461	Racks for cardboard and paper	411	Shredded paper	416	Tactile paper	361	Wool	435
		Rainbow paper	362	Sidewalk chalks	450	Taltine	334	Writing	452



Makerspace

• 2018

*B&B inaugurates its
Makerspace: when art and
technology meet!*

The Makerspace is a place where students and teachers create projects where they find their own solutions. It is a place for sharing, exchanging, trying, making mistakes, starting over and succeeding... together!

When an idea is launched or a project starts taking shape, the trial and error process brings the Makerspace to life.

Meeting place for a community of learners, it's not just about sharing tools, it's mainly about sharing knowledge and experiences.



The Makerspace resources can be found in the following sections of our 2019-2020 School catalog:
Robotics: pages 183 to 201
Science & Technology: pages 202 to 221
Arts and Creative leisure: pages 308 to 439

Let's celebrate
75years
of serious play!

View our **Makerspace**
themed booklet!
Look for this icon on www.bb.ca



**Contact your representative
to find out more about:**

- Planning your project
- Our turnkey solutions
- Our training

→ sales@bb.ca

General Conditions

Important notice

In order to help us serve you better, please indicate the name (and brand name, if applicable), as well as the reference number of each item on your order form.

Prices

Our prices are subject to market fluctuations and can change without notice.

Applicable taxes

Prices in the catalog do not include sales taxes, which will be applied separately on your invoice.

Availability of stock

Unless notified otherwise, any item that is not available will be replaced by an item of equivalent quality and cost. Any order that cannot be completed due to a product being out of stock will still be shipped, and the balance of the order will be shipped as soon as the items become available. Any order with a remaining balance of less than \$20.00 could be cancelled, in which case the items will have to be ordered again.

Returns

Any return of merchandise must be authorized within 90 days of reception. Please contact our Customer Service Department to obtain an authorization number. Depending on the condition of the returned items, re-stocking fees of 15% to 50% of the reimbursed merchandise could be applicable.

In order for a return to be authorized, any merchandise to be returned must bear an authorization number.

Claims

The receipt of an incomplete or damaged order must be reported immediately to the delivery person, who must indicate it on your bill of lading. All claims must be submitted to our Customer Service Department with the bill of lading and the authorization number.

General conditions – Shipping

The following chart indicates our shipping and handling fees according to the destination. A minimum order of \$25.00 is required.

Destination	Shipping		Overcharge (oversized item)
	Order amount	Applicable fees	
Québec* Ontario* New Brunswick* Nova Scotia* Prince Edward Island* Manitoba*	\$25 - \$49 → \$50 - \$249 → \$250 + →	\$13.50 per order 9 % (\$8.00 minimum) \$4.00 per order	Extra fees of up to 9% will be applied to the cost of the item, to a maximum fee of \$100.00 per order for items bearing the truck pictogram (not added to other fees). 
British Columbia* Alberta* Saskatchewan* Newfoundland* Labrador*	\$25 - \$49 → \$50 - \$599 → \$600 + →	\$13.50 per order 9 % (\$8.00 minimum) \$4.00 per order	Extra fees of up to 9% will be applied to the cost of the item, to a maximum fee of \$300.00 per order for items bearing the truck pictogram (not added to other fees). 
Other regions *Certain remote locations		FOB Montréal FOB Montréal	

* Some conditions apply. Please contact Customer Service for more information. Prices, terms and conditions are subject to change without notice.



*Since its creation in 1944,
Brault & Bouthillier is proud to contribute
to the overall development
of young people!*



Let's celebrate
75years
*of being seriously
creative!*

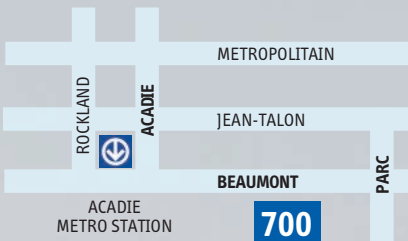

700 Beaumont Avenue
Montreal (Quebec) H3N 1V5
514 273-9186 / 1 800 361-0378
📍 Acadie metro station

4507067
\$ 4.95